

HIKVISION

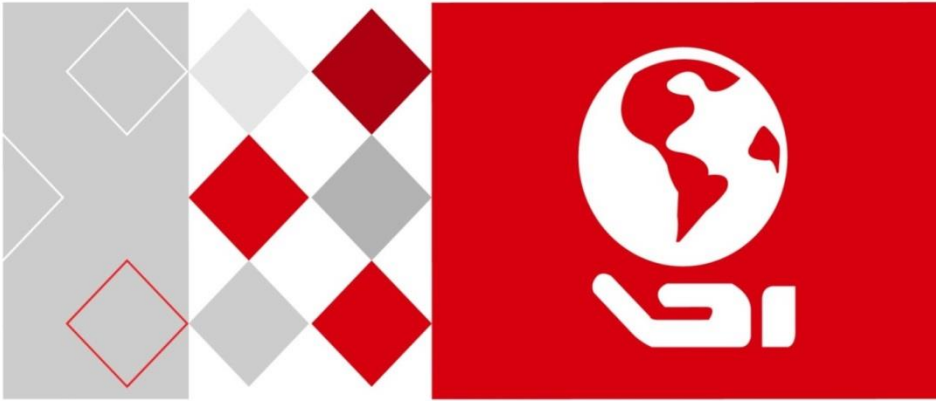

Video Intercom Door Station

(V Series)

User Manual

UD02940B

User Manual

©2016 Hangzhou Hikvision Digital Technology Co., Ltd.

This user manual is intended for users of the models below:

Series	Model
Door Station (V Series)	DS-KV8102-IM
	DS-KV8202-IM
	DS-KV8402-IM
	DS-KV8102-IP
	DS-KV8102-VP

It includes instructions on how to use the Product. The software embodied in the Product is governed by the user license agreement covering that product.

About this Manual

This Manual is subject to domestic and international copyright protection. Hangzhou Hikvision Digital Technology Co., Ltd. (“Hikvision”) reserves all rights to this manual. This manual cannot be reproduced, changed, translated, or distributed, partially or wholly, by any means, without the prior written permission of Hikvision.

Trademarks

HIKVISION and other Hikvision marks are the property of Hikvision and are registered trademarks or the subject of applications for the same by Hikvision and/or its affiliates. Other trademarks mentioned in this manual are the properties of their respective owners. No right of license is given to use such trademarks without express permission.

Disclaimer

TO THE MAXIMUM EXTENT PERMITTED BY APPLICABLE LAW, HIKVISION MAKES NO WARRANTIES, EXPRESS OR IMPLIED, INCLUDING WITHOUT LIMITATION THE IMPLIED WARRANTIES OF MERCHANTABILITY AND FITNESS FOR A PARTICULAR PURPOSE, REGARDING THIS MANUAL. HIKVISION DOES NOT WARRANT, GUARANTEE, OR MAKE ANY REPRESENTATIONS REGARDING THE USE OF THE MANUAL, OR THE CORRECTNESS, ACCURACY, OR RELIABILITY OF INFORMATION CONTAINED HEREIN. YOUR USE OF THIS MANUAL AND ANY RELIANCE ON THIS MANUAL SHALL BE WHOLLY AT YOUR OWN RISK AND RESPONSIBILITY.

TO THE MAXIMUM EXTENT PERMITTED BY APPLICABLE LAW, IN NO EVENT WILL HIKVISION, ITS DIRECTORS, OFFICERS, EMPLOYEES, OR AGENTS BE LIABLE TO YOU FOR ANY SPECIAL, CONSEQUENTIAL, INCIDENTAL, OR INDIRECT DAMAGES, INCLUDING, AMONG OTHERS, DAMAGES

Video Intercom Door Station • User Manual

FOR LOSS OF BUSINESS PROFITS, BUSINESS INTERRUPTION, SECURITY BREACHES, OR LOSS OF DATA OR DOCUMENTATION, IN CONNECTION WITH THE USE OF OR RELIANCE ON THIS MANUAL, EVEN IF HIKVISION HAS BEEN ADVISED OF THE POSSIBILITY OF SUCH DAMAGES.

SOME JURISDICTIONS DO NOT ALLOW THE EXCLUSION OR LIMITATION OF LIABILITY OR CERTAIN DAMAGES, SO SOME OR ALL OF THE ABOVE EXCLUSIONS OR LIMITATIONS MAY NOT APPLY TO YOU.

Support

Should you have any questions, please do not hesitate to contact your local dealer.

Regulatory Information

FCC Information

Please take attention that changes or modification not expressly approved by the party responsible for compliance could void the user's authority to operate the equipment.

FCC compliance: This equipment has been tested and found to comply with the limits for a Class B digital device, pursuant to part 15 of the FCC Rules. These limits are designed to provide reasonable protection against harmful interference in a residential installation. This equipment generates, uses and can radiate radio frequency energy and, if not installed and used in accordance with the instructions, may cause harmful interference to radio communications. However, there is no guarantee that interference will not occur in a particular installation. If this equipment does cause harmful interference to radio or television reception, which can be determined by turning the equipment off and on, the user is encouraged to try to correct the interference by one or more of the following measures:

- Reorient or relocate the receiving antenna.
- Increase the separation between the equipment and receiver.
- Connect the equipment into an outlet on a circuit different from that to which the receiver is connected.
- Consult the dealer or an experienced radio/TV technician for help.

This equipment should be installed and operated with a minimum distance 20cm between the radiator and your body.

FCC Conditions

This device complies with part 15 of the FCC Rules. Operation is subject to the following two conditions:

1. This device may not cause harmful interference.
2. This device must accept any interference received, including interference that may cause undesired operation.

EU Conformity Statement



This product and - if applicable - the supplied accessories too are marked with "CE" and comply therefore with the applicable harmonized European standards listed under the R&TTE Directive 1999/5/EC, the EMC Directive 2004/108/EC, the RoHS Directive 2011/65/EU.



2012/19/EU (WEEE directive): Products marked with this symbol cannot be disposed of as unsorted municipal waste in the European Union. For proper recycling, return this product to your local supplier upon the purchase of equivalent new equipment, or dispose of it at designated collection points. For more information see:

www.recyclethis.info



2006/66/EC (battery directive): This product contains a battery that cannot be disposed of as unsorted municipal waste in the European Union. See the product documentation for specific battery information. The battery is marked with this symbol, which may include lettering to indicate cadmium (Cd), lead (Pb), or mercury (Hg). For proper recycling, return the battery to your supplier or to a designated collection point. For more information see: www.recyclethis.info

Industry Canada ICES-003 Compliance

This device meets the CAN ICES-3 (B)/NMB-3(B) standards requirements.

This device complies with Industry Canada licence-exempt RSS standard(s). Operation is subject to the following two conditions:

- (1) this device may not cause interference, and
- (2) this device must accept any interference, including interference that may cause undesired operation of the device.

Le présent appareil est conforme aux CNR d'Industrie Canada applicables aux appareils radioexempts de licence. L'exploitation est autorisée aux deux conditions suivantes :

- (1) l'appareil ne doit pas produire de brouillage, et
- (2) l'utilisateur de l'appareil doit accepter tout brouillage radioélectrique subi, même si le brouillage est susceptible d'en compromettre le fonctionnement.

Under Industry Canada regulations, this radio transmitter may only operate using an antenna of a type and maximum (or lesser) gain approved for the transmitter by Industry Canada. To reduce potential radio interference to other users, the antenna type and its gain should be so chosen that the equivalent isotropically radiated power (e.i.r.p.) is not more than that necessary for successful communication.

Conformément à la réglementation d'Industrie Canada, le présent émetteur radio peut fonctionner avec une antenne d'un type et d'un gain maximal (ou inférieur) approuvé pour l'émetteur par Industrie Canada. Dans le but de réduire les risques de brouillage radioélectrique à l'intention des autres utilisateurs, il faut choisir le type d'antenne et son gain de sorte que la puissance isotrope rayonnée équivalente (p.i.r.e.) ne dépasse pas l'intensité nécessaire à l'établissement d'une communication satisfaisante.



Safety Instruction

These instructions are intended to ensure that user can use the product correctly to avoid danger or property loss.

The precaution measure is divided into **Warnings** and **Cautions**:

Warnings: Neglecting any of the warnings may cause serious injury or death.

Cautions: Neglecting any of the cautions may cause injury or equipment damage.

	
Warnings Follow these safeguards to prevent serious injury or death.	Cautions Follow these precautions to prevent potential injury or material damage.



Warnings

- All the electronic operation should be strictly compliance with the electrical safety regulations, fire prevention regulations and other related regulations in your local region.
- Please use the power adapter, which is provided by normal company. The power consumption cannot be less than the required value.
- Do not connect several devices to one power adapter as adapter overload may cause over-heat or fire hazard.
- Please make sure that the power has been disconnected before you wire, install or dismantle the device.
- When the product is installed on wall or ceiling, the device shall be firmly fixed.
- If smoke, odors or noise rise from the device, turn off the power at once and unplug the power cable, and then please contact the service center.
- If the product does not work properly, please contact your dealer or the nearest service center. Never attempt to disassemble the device yourself. (We shall not assume any responsibility for problems caused by unauthorized repair or maintenance.)



Cautions

- Do not drop the device or subject it to physical shock, and do not expose it to high electromagnetism radiation. Avoid the equipment installation on vibrations surface or places subject to shock (ignorance can cause equipment damage).
- Do not place the device in extremely hot (refer to the specification of the device for the detailed operating temperature), cold, dusty or damp locations, and do not expose it to high electromagnetic radiation.

- The device cover for indoor use shall be kept from rain and moisture.
- Exposing the equipment to direct sun light, low ventilation or heat source such as heater or radiator is forbidden (ignorance can cause fire danger).
- Do not aim the device at the sun or extra bright places. A blooming or smear may occur otherwise (which is not a malfunction however), and affecting the endurance of sensor at the same time.
- Please use the provided glove when open up the device cover, avoid direct contact with the device cover, because the acidic sweat of the fingers may erode the surface coating of the device cover.
- Please use a soft and dry cloth when clean inside and outside surfaces of the device cover, do not use alkaline detergents.
- Please keep all wrappers after unpack them for future use. In case of any failure occurred, you need to return the device to the factory with the original wrapper. Transportation without the original wrapper may result in damage on the device and lead to additional costs.
- Improper use or replacement of the battery may result in hazard of explosion. Replace with the same or equivalent type only. Dispose of used batteries according to the instructions provided by the battery manufacturer.

Table of Contents

1 Overview	1
1.1 Introduction.....	1
1.2 Main Features.....	1
2 Appearance	2
2.1 Appearance of DS-KV8X02-IM.....	2
2.2 Appearance of DS-KV8102-XP.....	3
3 Typical Application	5
3.1 Typical Application of DS-KV8X02-IM.....	5
3.2 Typical Application of DS-KV8102-XP.....	6
4 Terminals and Interfaces	7
5 Installation and Wiring	8
5.1 Installation of DS-KV8X02-IM.....	8
5.1.1 Gang Box for DS-KV8X02-IM.....	8
5.1.2 Wall Mounting with Gang Box of DS-KV8X02-IM.....	9
5.2 Installation of DS-KV8102-XP.....	10
5.2.1 Installation Plate for DS-KV8102-XP.....	10
5.2.2 Wall Mounting with Gang Box of DS-KV8102-XP.....	11
5.3 Wiring Description.....	13
5.3.1 Door Lock Wiring.....	13
5.3.2 Door Magnetic Wiring.....	14
5.3.3 Exit Button Wiring.....	14
5.3.4 Alarm Device Input Wiring.....	15
6 Before You Start	16
7 Remote Operation via Batch Configuration Tool	17
7.1 Activating Device Remotely.....	17
7.2 Editing Network Parameters.....	18
7.3 Adding Device.....	19
7.3.1 Adding Online Device.....	19
7.3.2 Adding by IP Address.....	20
7.3.3 Adding by IP Segment.....	21
7.4 Configuring Devices Remotely.....	22
7.4.1 System.....	22
7.4.2 Video Intercom.....	27
7.4.3 Network.....	31
7.4.4 Video Display.....	33
7.5 Video Intercom Device Set-up Tool.....	34
7.5.1 Setting a Community Structure.....	35
7.5.2 Setting Main/Sub Door Station.....	35

7.6 Batch Upgrading	38
7.6.1 Adding Devices for Upgrading	38
7.6.2 Upgrading Devices	40
8 Remote Operation via iVMS-4200	42
8.1 System Configuration	42
8.2 Device Management	43
8.2.1 Adding Video Intercom Devices	43
8.2.2 Modifying Network Information	46
8.2.3 Resetting Password	46
8.3 Configuring Devices Remotely via iVMS-4200	48
8.4 Picture Storage	48
8.4.1 Adding Storage Server	49
8.4.2 Formatting the HDDs	50
8.4.3 Configuring Storage Server Picture Storage	50
8.5 Video Intercom Configuration	52
8.5.1 Group Management	53
8.5.2 Video Intercom	58
8.5.3 Card Management	60
8.5.4 Notice Management	69
8.6 Device Arming Control	71
9 Local Operation	73
9.1 Calling Resident	73
9.1.1 Calling Resident (DS-KV8X02-IM)	73
9.1.2 Calling Resident (DS-KV8102-XP)	74
9.2 Issuing Card	75
9.3 Unlocking Door	76
Appendix	77
Installation Notice	77
Wiring Cables	77

1 Overview

1.1 Introduction

The door station (V series) can realize functions such as video intercom, access control, one-card system, zone alarm, and visitor messages to form a complete smart community video intercom solution.

The door station (V series) is mainly applied in the villa, and can work as door station, outer door station, and doorphone.

1.2 Main Features

- Video intercom function
- HD video surveillance (Max. resolution 1280×720@25fps, WDR, 120° wide angle)
- Self-adaptive light supplement
- Access control function
- Activating card via local station function (This function will be invalid if the card has been activated via iVMS-4200)
- Auto-uploading captured pictures to FTP or iVMS-4200 Client while unlocking the door
- Door magnetic alarm and tamper alarm function
- Noise suppression and echo cancellation
- Remote upgrade, batch setting functions

2 Appearance

2.1 Appearance of DS-KV8X02-IM

For device DS-KV8X02-IM, the number of call buttons varies according to its model. Take the figure of device DS-KV8402-IM as an example.



- For device DS-KV8102-IM, there is only 1 call button.
- For device DS-KV8202-IM, there are 2 call buttons.
- For device DS-KV8402-IM, there are 4 call buttons.

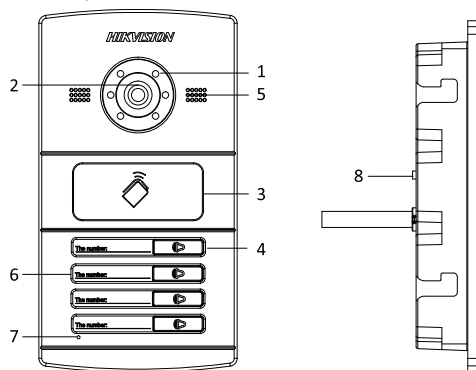

Figure 2-1 Appearance of DS-KV8402-IM

Table 2-1 Description of DS-KV8X02-IM

Models	No.	Description
DS-KV8102-IM DS-KV8202-IM DS-KV8402-IM	1	Low Illumination Supplement Light
	2	Built-in Camera
	3	Card Induction Area
	4	Call Button
	5	Loudspeaker
	6	Room No. (Customized)
	7	Microphone
	8	Tamper Button



- You need not customize the Room No. for device DS-KV8102-IM.
- Default settings of call button: when you press the call button, it calls the resident; and when you hold down the call button, it calls the center.
- You can change the calling mode of the call button via Batch Configuration Tool or iVMS-4200 client software. See 7.4.2 *Video Intercom* for detail steps.

2.2 Appearance of DS-KV8102-XP

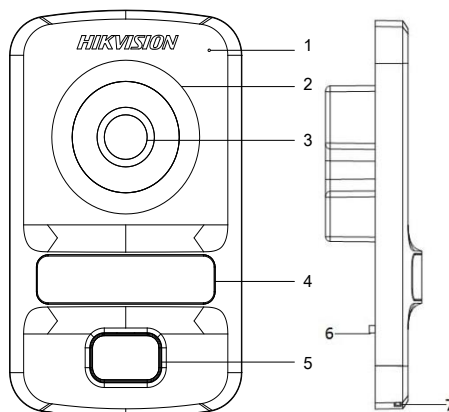

Figure 2-2 Appearance of DS-KV8102-XP

Table 2-2 Description of DS-KV8102-XP

Models	No.	Description
DS-KV8102-IP DS-KV8102-VP	1	Microphone
	2	Low Illumination Supplement Light
	3	Built-in Camera
	4	Card Induction Area
	5	Call Button
	6	Tamper Button
	7	Loudspeaker



- Default settings of call button: when you press the call button, it calls the resident; and when you hold down the call button, it calls the center.
- You can change the calling mode of the call button via Batch Configuration Tool or iVMS-4200 client software. See 7.4.2 *Video Intercom* for detail steps.

3 Typical Application

3.1 Typical Application of DS-KV8X02-IM

Please refer to the following figure for typical application of DS-KV8102-IM/ DS-KV8202-IM/ DS-KV8402-IM door station.

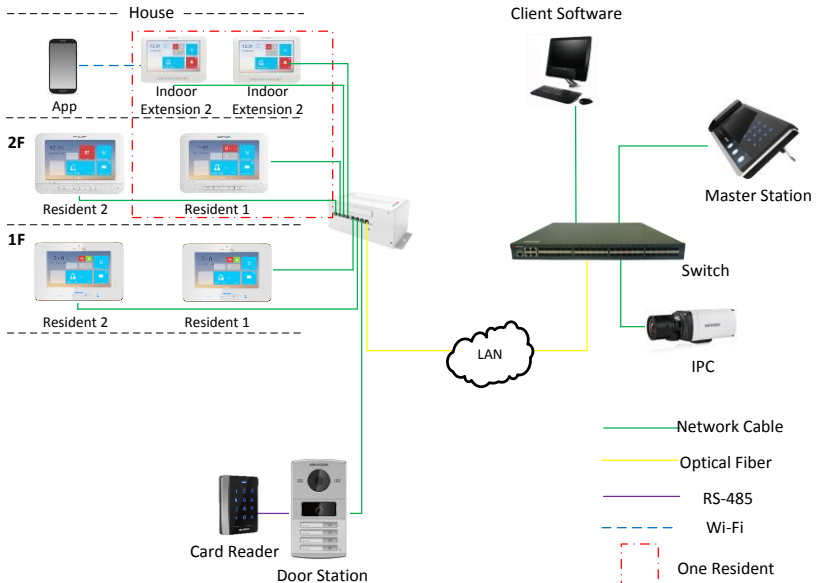

Figure 3-1 Typical Application of DS-KV8X02-IM

3.2 Typical Application of DS-KV8102-XP

Please refer to the following figures for typical applications of DS-KV8102-IP/DS-KV8102-VP door station.

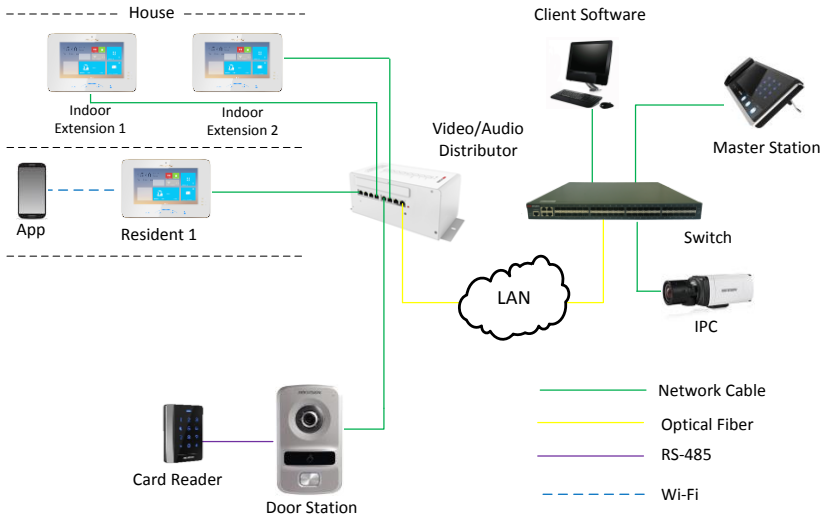

Figure 3-2 Typical Application of DS-KV8102-XP

4 Terminals and Interfaces

Please refer to the following figure for terminals and interfaces of door station.

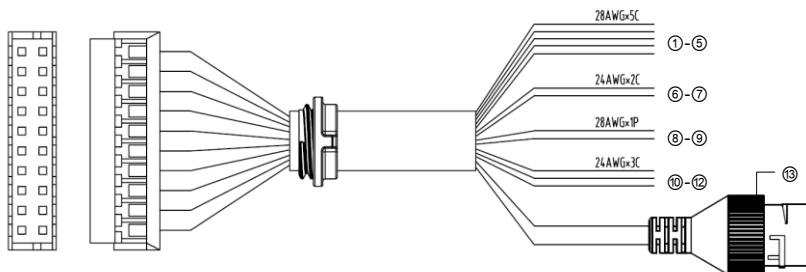

Figure 4-1 Terminals and Interfaces

Table 4-1 Descriptions of Terminals and Interfaces

Terminals and Interfaces			
Name	No.	Color	Description
ALARM IN	1	YELLOW/BLUE	ALARM_1
	2	YELLOW/ORANGE	ALARM_2
	3	YELLOW/GREEN	ALARM_3
	4	YELLOW/BROWN	ALARM_4
	5	YELLOW/BLACK	ALARM_GND
Power Supply	6	RED	DC 12V Power Supply Input
GND	7	BLACK	Grounding
RS485	8	ORANGE	RS485+
	9	YELLOW	RS485-
ALARM OUT	10	PINK	DR_NC
	11	BLUE	DR_NO
	12	BROWN	DR_COM
LAN	13	LAN	Network Interface



- 4 I/O Input terminals (ALARM_1~ALARM_4) can be set as door magnetic input or door switch key input, and terminal ALARM_GND is for grounding connection.
- 1 I/O Output terminal can be enabled for controlling electric lock or disabled.

5 Installation and Wiring

5.1 Installation of DS-KV8X02-IM

To install the door station onto the wall, you are required to utilize a matched gang box.

5.1.1 Gang Box for DS-KV8X02-IM

Please refer to the following figures for the dimensions of gang box for DS-KV8102-IM/ DS-KV8202-IM/ DS-KV8402-IM door station.

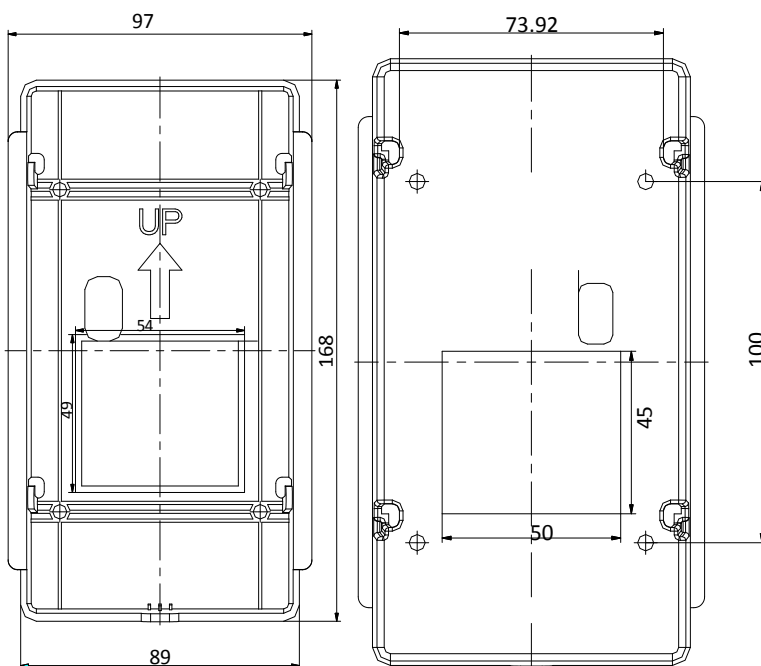

Figure 5-1 Front View & Rear View (DS-KV8X02-IM)



- The dimension of gang box for model DS-KV8102-IM/ DS-KV8202-IM/ DS-KV8402-IM door station is: 89 (width) × 168 (length) × 38 (depth) mm.

- The dimensions above are theoretical. The actual size can be slightly different from the theoretical dimension.

5.1.2 Wall Mounting with Gang Box of DS-KV8X02-IM

Steps:

1. Take the gang box and screws from the packing box.
2. Chisel a hole in the wall for inserting the gang box. The size of the hole should be 90 (width) × 170 (length) × 38 (depth) mm.
3. Insert the gang box into the hole and fix it with 4 PA4 screws, as shown in the figure below.

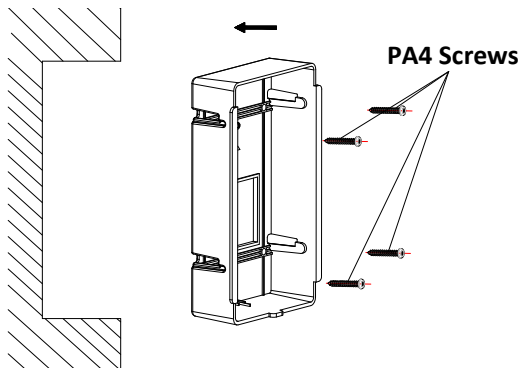

Figure 5-2 Insert the Gang Box (DS-KV8X02-IM)

4. After fixing the gang box, install the door station into the gang box according to the direction of the arrow, as shown in the figure below.

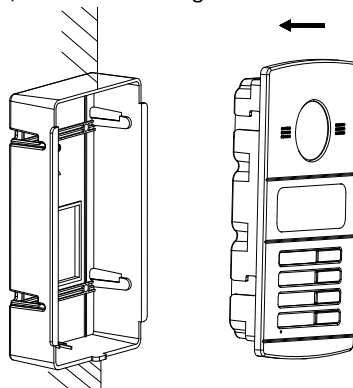

Figure 5-3 Insert the Door Station (DS-KV8X02-IM)

5. After inserting the door station into the gang box, pull the device downwards to hook the door station with the gang box.
6. Secure the door station by inserting the fixing screw according to the direction of the arrow of the figure below.

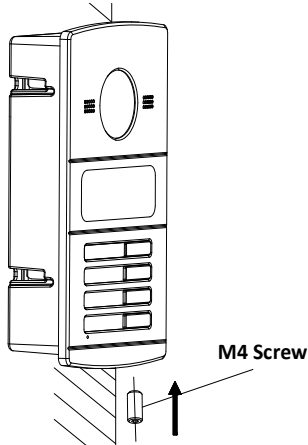

Figure 5-4 Secure the Door Station (DS-KV8X02-IM)

5.2 Installation of DS-KV8102-XP

5.2.1 Installation Plate for DS-KV8102-XP

To install the DS-KV8102-XP model onto the wall, an installation plate and a gang box are required.

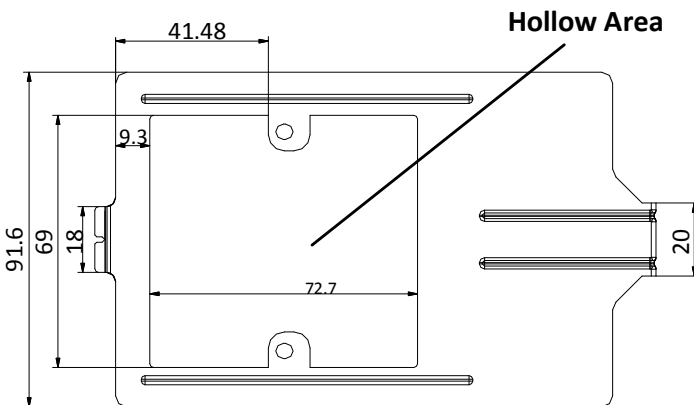

Figure 5-5 Dimensions of Installation Plate (DS-KV8102-XP)



- The dimension of gang box for model DS-KV8102-IP/ DS-KV8102-VP door station is: 75 (width) × 75 (length) × 50 (depth) mm.
- The dimensions above are theoretical. The actual size can be slightly different from the theoretical dimension.

5.2.2 Wall Mounting with Gang Box of DS-KV8102-XP

Steps:

1. Take the gang box, installation plate and screws from the packing box.
2. Chisel a hole in the wall for inserting the gang box. The size of the hole should be 76 (width) × 76 (length) × 50 (depth) mm.
3. Insert the gang box into the hole, as shown in the figure below.

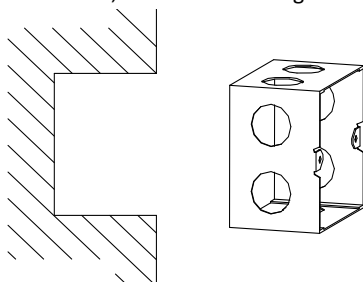

Figure 5-6 Insert the Gang Box (DS-KV8102-XP)

4. Attach the installation plate to the gang box and align the screw holes of the installation plate with the screw holes of the gang box.
5. Insert 2 PA4 screws and a KA4 screw into the screw holes to fix the installation plate onto the gang box. (The KA4 screw is optional.)

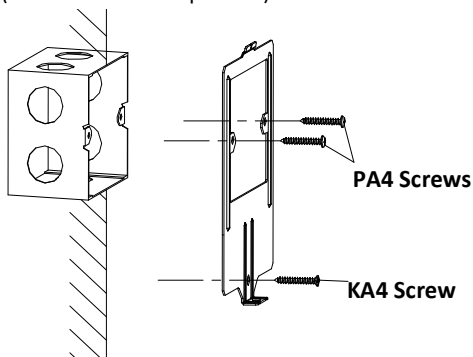

Figure 5-7 Attach the Installation Plate (DS-KV8102-XP)

6. After installing the installation plate, install the door station by inserting the rear component into the hollow area of the installation plate.



While inserting the door station into the installation plate, incline the device by 5~10° , as shown in the figure below.

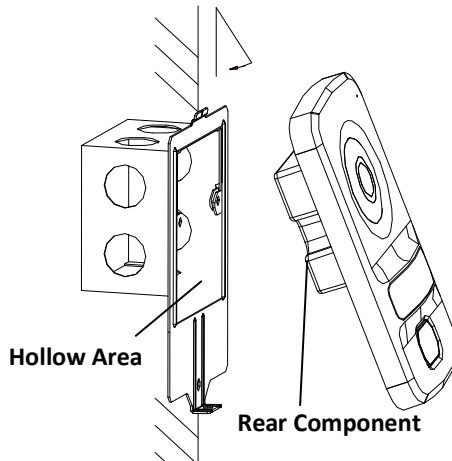

Figure 5-8 Install the Door Station (DS-KV8102-XP)

7. Secure the door station by inserting the fixing screw according to the direction of the arrow of the figure below.

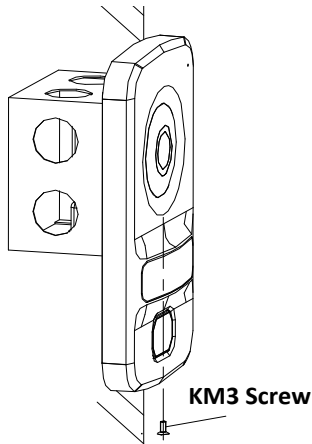

Figure 5-9 Secure the Door Station (DS-KV8102-XP)

5.3 Wiring Description

5.3.1 Door Lock Wiring

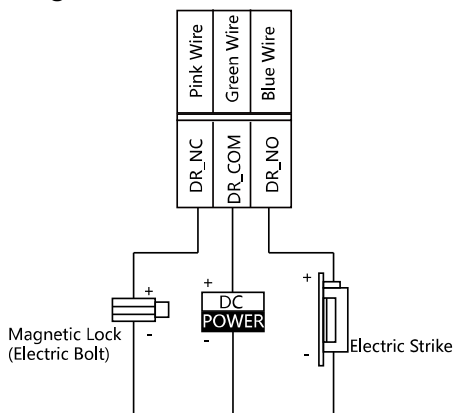

Figure 5-10 Door Lock Wiring



- Terminal DR_NC/DR_COM is set as default for connecting magnetic lock/electric bolt; terminal DR_NO/DR_COM is set as default for connecting electric strike.
- To connect electric lock, it is required to set the output of terminal DR_NC/DR_COM/DR_NO to be electric lock with Batch Configuration Tool or iVMS-4200 client software.

5.3.2 Door Magnetic Wiring

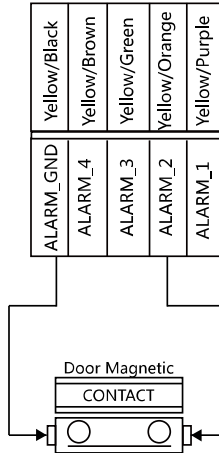

Figure 5-11 Door Magnetic Wiring



To connect door magnetic, it is required to set the input of one alarm in terminal (ALARM_1, ALARM_2, ALARM_3, or ALARM_4) to be door magnetic with Batch Configuration Tool or iVMS-4200 client software.

5.3.3 Exit Button Wiring

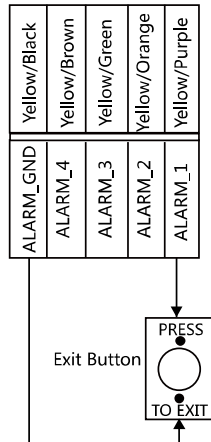

Figure 5-12 Exit Button Wiring



To connect exit button, it is required to set the input of one alarm in terminal (ALARM_1, ALARM_2, ALARM_3, or ALARM_4) to be exit button with Batch Configuration Tool or iVMS-4200 client software.

5.3.4 Alarm Device Input Wiring

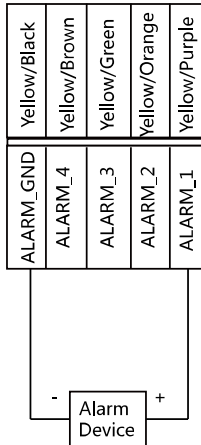

Figure 5-13 Alarm Device Input Wiring



To connect other alarm devices, it is required to set the input of one alarm in terminal (ALARM_1, ALARM_2, ALARM_3, or ALARM_4) to be custom with Batch Configuration Tool or iVMS-4200 client software.

6 Before You Start

For the first time use of the device, you are required to activate the device. You can activate the device and set the device password via internet with Batch Configuration Tool, or with iVMS-4200 client software, or with Video Intercom Set-up Tool.



To activate the device with Batch Configuration Tool or iVMS-4200, refer to 7 *Remote Operation via Batch Configuration Tool* and 8 *Remote Operation via iVMS-4200*.

Please refer to 7.1 for creating the device password.

7 Remote Operation via Batch Configuration Tool

7.1 Activating Device Remotely

Purpose:

You are required to activate the device first by setting a strong password for it before you can use the device.

Activation via Batch Configuration Tool, and Activation via iVMS-4200 are supported. Here take activation via Batch Configuration Tool as example to introduce the device activation. Please refer to the user manual for the activation via iVMS-4200.

Steps:

1. Run the Batch Configuration Tool.

Index	Device Type	IP Address	Port	Software Version	Serial No.	Security Status	Added
1	XX-XXXX-XX	10.16.2.77	8000	Vx.x.x build xxxxxx	XX-XXXXX-XXXXXXXXXXXXXXXXXXXXXXXXXXXX	Activated	Yes
2	XX-XXXX-XX	10.16.2.103	8000	Vx.x.x build xxxxxx	XX-XXXXX-XXXXXXXXXXXXXXXXXXXXXXXXXXXX	Activated	No
3	XX-XXXX-XX	10.16.2.114	8000	Vx.x.x build xxxxxx	XX-XXXXX-XXXXXXXXXXXXXXXXXXXXXXXXXXXX	Activated	No
4	XX-XXXX-XX	10.16.2.222	8000	Vx.x.x build xxxxxx	XX-XXXXX-XXXXXXXXXXXXXXXXXXXXXXXXXXXX	Activated	No
5	XX-XXXX-XX	192.0.0.65	8000	Vx.x.x build xxxxxx	XX-XXXXX-XXXXXXXXXXXXXXXXXXXXXXXXXXXX	Inactive	No

Figure 7-1 Selecting Inactive Device

2. Select an inactivated device and click the **Activate** button.

Activate

Password:

Valid password range [8-16].
You can use a combination
of numbers, lowercase,
uppercase and special
character for your password
with at least two kinds of
them contained.

Confirm password:

OK Cancel

Figure 7-2 Activation

3. Create a password, and confirm the password.

STRONG PASSWORD RECOMMENDED– We highly recommend you create a strong password of your own choosing (Using a minimum of 8 characters, including at least three of the following categories: upper case letters, lower case letters, numbers, and special characters.) in order to increase the security of your product. And we recommend you reset your password regularly, especially in the high security system, resetting the password monthly or weekly can better protect your product.



4. Click the **OK** button to activate the device.



- When the device is not activated, the basic operation and remote operation of device cannot be performed.
- You can hold the **Ctrl** or **Shift** key to select multiple devices in the online devices, and click the **Activate** button to activate devices in batch.

7.2 Editing Network Parameters

Purpose:

To operate and configure the device via LAN (Local Area Network), you need connect the device in the same subnet with you PC. You can edit network parameters via batch configuration tool, and iVMS-4200 software. Here take editing network parameters via batch configuration tool as example.

Steps:

1. Select an online activated device and click the **Edit NET Parameters** button.

Online Devices: 5							
Edit NET Parameters Reset Password Activate							
Index	Device Type	IP Address	Port	Software Version	Serial No.	Security Status	Added
1	XX-XXXX-XX	10.16.2.77	8000	V1.0.0 build xxxxxx	XX-XXXX-XXXXXXXXXXXXXXXXXXXXXX	Activated	Yes
2	XX-XXXX-XX	10.16.2.114	8000	V1.0.0 build xxxxxx	XX-XXXX-XXXXXXXXXXXXXXXXXXXXXX	Activated	No
3	XX-XXXX-XX	10.16.2.103	8000	V1.0.0 build xxxxxx	XX-XXXX-XXXXXXXXXXXXXXXXXXXXXX	Activated	No
4	XX-XXXX-XX	192.0.0.85	8000	V1.0.0 build xxxxxx	XX-XXXX-XXXXXXXXXXXXXXXXXXXXXX	Activated	No
5	XX-XXXX-XX	10.16.2.222	8000	V1.0.0 build xxxxxx	XX-XXXX-XXXXXXXXXXXXXXXXXXXXXX	Activated	No

Figure 7-3 Clicking Edit NET Parameters Button

2. Change the device IP address and gateway address to the same subnet with your computer.
3. Enter the password and click the **OK** button to activate the network parameters modification.

Figure 7-4 Editing Network Parameters



- The default port No. is 8000.
- After editing the network parameters of device, you should add the devices to the device list again.

7.3 Adding Device

Before you start:

Make sure the device to be added has been activated.

Purpose:

For batch configuration tool software, you should add device to the software so as to configure the device remotely.

The software provides 3 ways for adding the devices. You can add the active online devices within your subnet, add devices by IP address, and add devices by IP segment.

7.3.1 Adding Online Device

Before you start:

Make sure the device to be added is in the same subnet with your computer. Otherwise, please edit network parameters first.

Steps:

1. Select an active online device or hold the **Ctrl** or **Shift** key to select multiple devices in the online devices list.

Index	Device Type	IP Address	Port	Software Version	Serial No.	Security Status	Added
1	XX-XXXX-XX	10.16.2.77	8000	Vx.x.x build xxxxxx	XX-XXXX-XXXXXXXXXXXXXXXXXXXXXX	Activated	Yes
2	XX-XXXX-XX	10.16.2.114	8000	Vx.x.x build xxxxxx	XX-XXXX-XXXXXXXXXXXXXXXXXXXXXX	Activated	No
3	XX-XXXX-XX	10.16.2.103	8000	Vx.x.x build xxxxxx	XX-XXXX-XXXXXXXXXXXXXXXXXXXXXX	Activated	No
4	XX-XXXX-XX	10.16.2.88	8000	Vx.x.x build xxxxxx	XX-XXXX-XXXXXXXXXXXXXXXXXXXXXX	Activated	No
5	XX-XXXX-XX	10.16.2.222	8000	Vx.x.x build xxxxxx	XX-XXXX-XXXXXXXXXXXXXXXXXXXXXX	Activated	No

Figure 7-5 Online Devices Interface

- Click the  button to pop up the login dialog box.

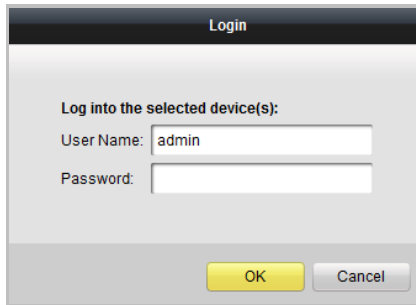

The image shows a 'Login' dialog box with a title bar. Below the title bar, it says 'Log into the selected device(s):'. There are two input fields: 'User Name:' with the text 'admin' and 'Password:'. At the bottom, there are two buttons: 'OK' (highlighted in yellow) and 'Cancel'.

Figure 7-6 Login Dialog Box

- Enter the user name and password.
- Click the **OK** button to save the settings.



- Only devices successfully logged in will be added to the device list for configuration.
- If you add devices in batch, please make sure selected devices have the same user name and password.

7.3.2 Adding by IP Address

Purpose:

You can add the device by entering IP address.

Steps:

- Click the  button to pop up the adding devices dialog box.

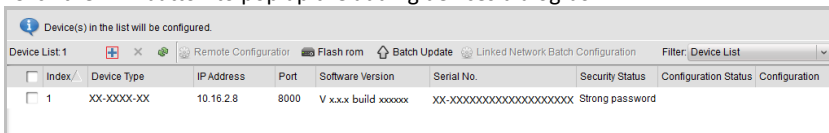

The image shows a 'Device List' dialog box with a title bar that says 'Device(s) in the list will be configured.' Below the title bar, there are several tabs: 'Device List 1', 'Remote Configuration', 'Flash rom', 'Batch Update', and 'Linked Network Batch Configuration'. A dropdown menu is set to 'Filter: Device List'. Below the tabs is a table with the following data:

Index	Device Type	IP Address	Port	Software Version	Serial No.	Security Status	Configuration Status	Configuration
1	XX-XXXX-XX	10.16.2.8	8000	V x.x.x build xxxxxx	XX-XXXXXXXXXXXXXXXXXXXX	Strong password		

Figure 7-7 Adding Button

- Select IP Address in the adding mode drop-down list.
- Enter the IP address, and set the port No., user name and password of the device.

Figure 7-8 Adding by IP Address

4. Click the **OK** button to add the device to the device list.



- You cannot add the device(s) to the device list if the user name and password are not identical.
- When you add devices by IP Address, IP Segment or Port No., the devices should be online devices.

7.3.3 Adding by IP Segment

Purpose:

You can add many devices at once whose IP addresses are among the IP segment.

Steps:

1. Click the  button to pop up the adding devices dialog box.

Index	Device Type	IP Address	Port	Software Version	Serial No.	Security Status	Configuration Status	Configuration
1	XX-XXXX-XX	10.16.2.8	8000	V x.x.x build xxxxxx	XX-XXXXXXXXXXXXXXXXXXXX	Strong password		

Figure 7-9 Adding Button

2. Select IP Segment in the adding mode drop-down list.
3. Set the Start IP Address and End IP Address.
4. Enter port No., user name, and password.

The 'Add' dialog box contains the following fields:

- Adding Mode: IP Segment (dropdown menu)
- Start IP Address: [text input]
- End IP Address: [text input]
- Port No.: 8000 (text input)
- User Name: admin (text input)
- Password: [masked with dots]

Buttons: OK, Cancel

Figure 7-10 Adding by IP Segment

- Click the **OK** button to search and add the devices whose IP addresses are within the range of the defined IP segment to the device list.

7.4 Configuring Devices Remotely

In the device list area, select a device and click **Remote Configuration** or to enter the remote configuration interface.

Index	Device Type	IP Address	Port	Software Version	Serial No.	Security Status	Configuration Status	Configuration
1	XX-XXXX-XX	10.16.2.99	8000	Vx.x.x build xxxxxx	XX-XXXX-XXXXXXXXXXXXXX...	Weak password		

Buttons: Remote Configuration and Export Configuration

Figure 7-11 Remote Configuration

7.4.1 System

Click the **System** button on the remote configuration interface to display the device information: Device Information, General, Time, System Maintenance, User, and RS485, and so on.

Device Information

Click the **Device Information** button to enter device basic information interface. You can view basic information (the device type, and serial No.), and version information of the device.

Basic Information

Device Type: XX-XXXX-XX

Device Serial No.: XX-XXXX-XXXXXXXXXXXXXXXXXXXXXX

Version Information

Version: Vx.x.x build xxxxxx

Hardware Version: xxxxxx

Figure 7-12 Device Information

General

Click the **General** button to enter device general parameters settings interface. You can view and edit the device name and device ID.

Figure 7-13 General

Time

Steps:

1. Click the **Time** button to enter the device time settings interface.

Figure 7-14 Time Settings

2. Select Time Zone or Enable NTP.

- **Time Zone**

- 1) Select a time zone from the drop-down list menu.
- 2) Click the **Synchronization** button.

- **NTP**

- 1) Check the checkbox of Enable NTP to enable NTP.
- 2) Enter the server address, NTP port, and synchronization interval.

- **DST**

- 1) Check the checkbox of Enable DST to enable DST.
- 2) Enter the start time and end time of DST, and set the DST bias.

3. Click the **Save** button to save and realize the time settings.



- The default port No. is 123.

System Maintenance

Purpose:

You can operate the system management and remote upgrading on the system maintenance interface.

Steps:

1. Click the **System Maintenance** button to enter the system maintenance interface.

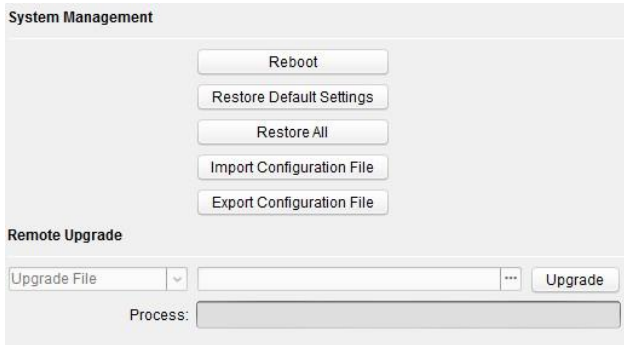

Figure 7-15 System Maintenance

2. Click **Reboot** and the system reboot dialog box pops up. Click **Yes** to reboot the system.
3. Click **Restore Default Settings** to restore the default parameters.
4. Click **Restore All** to restore all parameters of device and reset the device to inactive status.
5. Click **Import Configuration File** and the import file window pops up. Select the path of remote configuration files. Click **Open** to import the remote configuration file. The configuration file is imported and the device will reboot automatically.

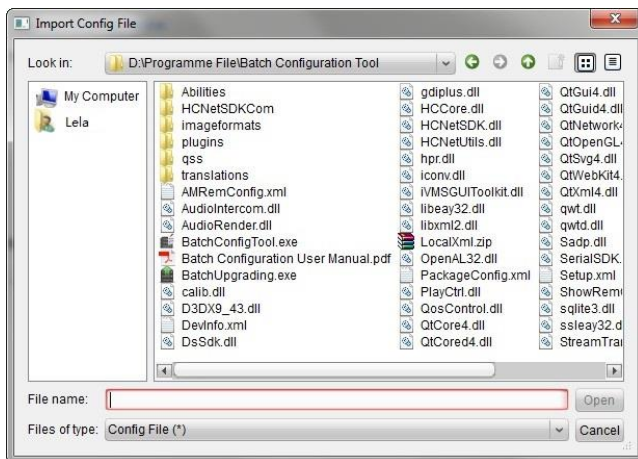

Figure 7-16 Import File

6. Click **Export Configuration File** and the export file window pops up. Select the saving path of remote configuration files and click **Save** to export the configuration file.

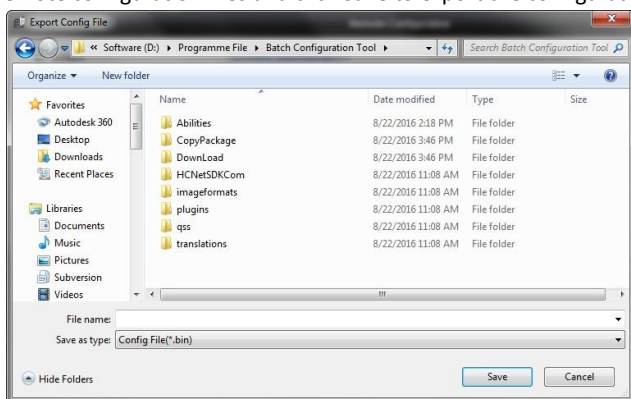

Figure 7-17 Export File

7. Click to select the upgrade file and click **Upgrade** to remote upgrade the device. The process of remote upgrade will be displayed in the process bar.

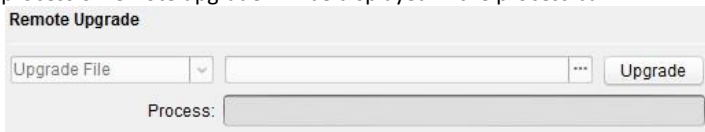

Figure 7-18 Remote Upgrade



- Click **Restore Default Settings** button, all default settings, excluding network parameters, will be restored.
- Click **Restore All** button, all default settings, including network parameters, will be restored. The device will be reset to inactivated status.

User

Purpose:

You can edit the password for logging in the device.

Steps:

1. Click the **User** button to enter the user information editing interface.



Figure 7-19 Select User Name

2. Select the user to edit and click the **Modify** button to enter the user parameter interface.

User Information

User Type: User Name:

Password: Confirm Password:

IP Address: MAC Address:

User Primission

- Local PTZ Control
- Local Manual Recording
- Local Playback
- Local Parameter Settings
- Local Log Search
- Local Advanced Operation
- Local Parameters View
- Local Camera Management
- Local Video Export
- Local Shutdown / Reboot

Figure 7-20 Modify User Information

3. Enter the new password, and confirm it.
4. Click the **Save** button to realize the editing of password.



- The new password and confirm password should be identical.

- After editing the password of device, click  button from the device list, the added device will not be there. You should add the device again with new password to operate the remote configuration.

RS485

Click the **RS485** button to enter the RS485 setting interface. You can view and edit the RS485 parameters of the device.

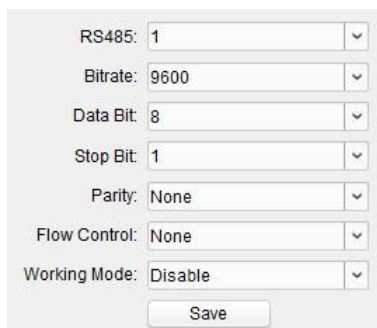

RS485: 1

Bittate: 9600

Data Bit: 8

Stop Bit: 1

Parity: None

Flow Control: None

Working Mode: Disable

Save

Figure 7-21 RS-485



- For door station (V series), there are 4 choices for the working mode: transparent channel, card reader, disable, and custom.

7.4.2 Video Intercom

Click the **Video Intercom** button on the remote configuration interface to enter the video intercom parameters settings: Device Number Configuration, Time Parameters, Password, Zone Configuration, IP Camera Information, and Volume Input and Output Configuration, and so on.

Device ID Configuration

Steps:

1. Click the **ID Configuration** button to enter device ID configuration interface.

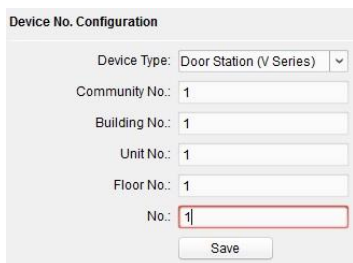

Device No. Configuration

Device Type: Door Station (V Series)

Community No.: 1

Building No.: 1

Unit No.: 1

Floor No.: 1

No.: 1

Save



Device No. Configuration

Device Type: Doorphone

Save

Figure 7-22 ID Configuration (Villa Door Station and Doorphone)

2. Select the device type from the drop-down list, and set the corresponding information.
3. Click the **Save** button to enable the device number configuration.



- For main door station (D series or V series), the serial No. is 0.
- For sub door station (D series or V series), the serial No. is higher than 0. Serial No. ranges from 1 to 99.
- For each villa or building, at least one main door station (D series or V series) should be configured, and sub door stations (D series or V series) can be customized.
- For one main door station (D series or V series), at most 8 sub door stations can be customized.
- Select doorphone as device type, and the serial No. is not necessary to configure. Please utilize the doorphone along with the main door station (V Series or D Series).
- V series door station cannot be used as outer door station.

Time Parameters

1. Click the **Time Parameters** button to enter time parameters settings interface.
2. Configure the maximum ring duration, maximum live view time, and call forwarding time.
3. Click the **Save** button.

Time Parameters

Device Type: Door Station (V Series) ▾

Max. Speaking Duration: 90 s

Max. Message Duration: 60 s

Save

Figure 7-23 Time Parameters



- For door station, maximum speaking time and maximum message time should be configured. Maximum speaking time varies from 90s to 120s, and maximum message time varies from 30s to 60s.

Access Control and Elevator

Step:

1. Click the **Access Control and Elevator** button to enter password changing interface.

Access Control

Delayed Door Alarm

Door No.:

Door-unlocked Duration: s

Encrypt Card

Elevator Control

Elevator No.:

Interface Type:

RS485 Protocol:

LAN Protocol:

Enable Or Not:

Server IP Address:

Server Port:

Figure 7-24 Access Control and Elevator Configuration

2. Set corresponding parameters on the access control and elevator settings interface.

- **Access Control**

- 1) Select the door No.
- 2) Set the door-unlocked duration.
- 3) (Optional) Enable the function of Delay Door Alarm.
- 4) Click the **Save** button to enable the settings.



Enabling **Card Encrypt**, the door station can recognize the encrypted information of the card when you swiping the card on the door station.

- **Elevator Control**

- 1) Select the elevator No., interface, RS485 protocol.
- 2) Select Yes/No of the elevator linkage.
- 3) Enter the server IP address and server port No..

3. Click the **Save** button to enable the settings.



This function only applies to door stations, except for the doorphone.

IO Input and Output

Step:

1. Click the **I/O Input and Output** button to enter the I/O input and output interface.

The screenshot shows a configuration window with two main sections: 'IO Input' and 'IO Output'. In the 'IO Input' section, there are two dropdown menus: 'IO Input No.' is set to 'AI1' and 'Input' is set to 'Exit Button'. In the 'IO Output' section, there are two dropdown menus: 'IO Output No.' is set to 'COM' and 'Output' is set to 'Electric Lock'. At the bottom of the window is a 'Save' button.

Figure 7-25 IO Input/Output Configuration

2. Select I/O input No., input mode, output No., and output mode.
3. Click the **Save** button to enable the settings.



- For door station (V series), there are 4 I/O Input Terminals, corresponding to **SENSOR** interfaces (S1, S2, S3, S4) of door station.
- For door station (D series and V series), there are 4 I/O Output Terminals. Terminal 1~2 correspond to **DOOR** interfaces (NO1/COM1/NC1; NO2/COM2/NC2) of door station. You can enable/disable IO Out by selecting from the dropdown list. Terminal 3~4 correspond to interfaces of **ALARM OUT** (AO1+, AO1-; AO2+, AO2-).

Volume Input and Output

Step:

1. Click **Volume Input/Output** button to enter the volume input and output interface.

The screenshot shows a configuration window with two main sections: 'Volume Input' and 'Volume Output'. Each section has a horizontal slider control. The 'Volume Input' slider is set to the value 7. The 'Volume Output' slider is also set to the value 7. At the bottom of the window is a 'Save' button.

Figure 7-26 Volume Configuration

2. Slide the slider to adjust the volume input and volume output.
3. Click the **Save** button to enable the settings.

Call Button

1. Click the **Call Buttons** button to enter the calling buttons settings interface.

Figure 7-27 Call Buttons Interface

2. Select the button number.
3. Enter the floor No. and the room No..
4. Click the **Save** button to enable the settings.



- For DS-KV8102-IM, DS-KV8102-IP, and DS-KV8102-VP, there is no need setting the Room No..
- If enabling Quick Press for Calling Center, you should call resident by holding down the call button, and call center by quickly pressing the call button.

7.4.3 Network

Local Network Configuration

Steps:

1. Click the **Local Network Configuration** button to enter local network configuration interface.

Figure 7-28 Local Network Parameters

2. Enter the local IP address, subnet mask, gateway address, and port No..
3. Click the **Save** button to enable the settings.



- The default port No. is 8000.

- After editing the local network parameters of device, you should add the devices to the device list again.

Linked Devices Network Configuration

Purpose:

In the linked devices network configuration interface, you can configure the network parameters of master stations, SIP servers and management centers of the same LAN. The devices can be linked to the door station and realize the linkage between these devices.

Steps:

1. Click the **Linked Network Configuration** button to enter linked network configuration interface.

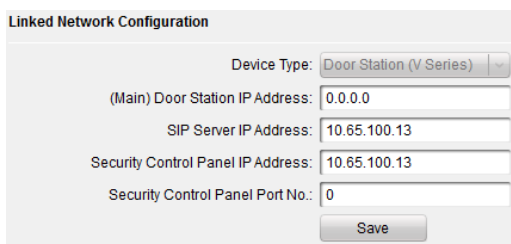

Linked Network Configuration

Device Type: Door Station (V Series)

(Main) Door Station IP Address: 0.0.0.0

SIP Server IP Address: 10.65.100.13

Security Control Panel IP Address: 10.65.100.13

Security Control Panel Port No.: 0

Save

Figure 7-29 Linked Network Configuration

2. Enter the master station IP address, (main) door station IP address, SIP server IP address, management center IP address, and doorphone IP address.
3. Select the main door station type from the drop-down list.
4. Click the **Save** button to enable the settings.



- After adding master station IP Address, the linkage between indoor station and master station can be realized.
- After adding the door station IP Address, the video intercom between indoor stations of same building can be realized.
- After adding SIP Server Address IP, the video intercom of same community: video intercom between indoor stations of different building, calling indoor station from outer door station and video intercom between management center and indoors.
- After adding management center IP Address, the events can be uploaded to the management center.
- For indoor extension, only parameter about the main indoor station should be configured.

FTP

Steps:

1. Click the **FTP** button to enter the FTP parameters interface.

Enable Main FTP

Server Type: IP Address

FTP Server: 0.0.0.0

Port: 21

Enable Anonymous:

User Name:

Password:

Directory: Save in the Child Direc...

Parent Directory: Community No.-Buildi...

Child Directory: Enable Time

Picture Naming Rule Separator: _

Name: Item 1

Named Element: Time

Save

Figure 7-30 FTP Configuration

2. Check the checkbox of **Enable Main FTP**.
3. Select IP address from the drop-down list of server mode.
4. Enter the FTP server address, and port No..
5. Check the checkbox to enable the anonymity (optional).
6. Enter the name and password.
7. Select the directory structure and set the separator, naming item, and naming element.
8. Click the **Save** button to enable the FTP parameters settings.



- The default port No. is 21.
- To enable anonymity or not is according to whether the FTP server enables anonymity.
- After configuring the FTP parameters, the captured pictures of door station will be uploaded to the FTP server automatically.
- This function only applies to the door station, except for the doorphone.

7.4.4 Video Display

Steps:

1. Click the **Video Display** button to enter the video parameters interface.

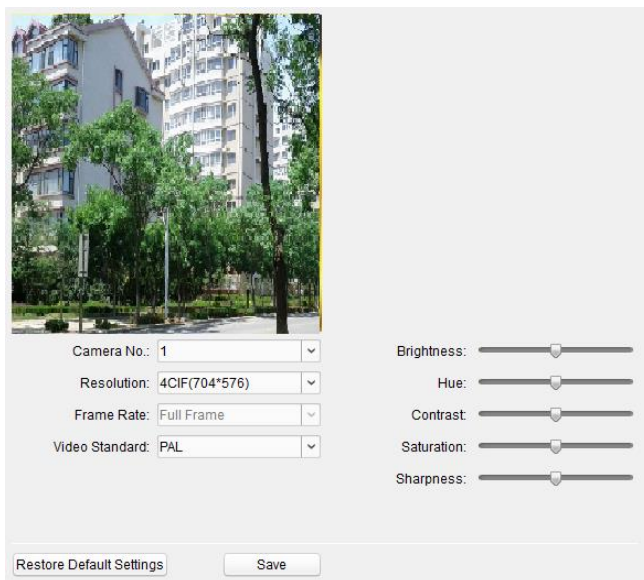

Figure 7-31 Video Display

2. Select the camera No..
3. Select the video standard (PAL and NTSC can be selected).
4. Set the brightness, contrast, and saturation of the video.
5. Click the **Save** button to enable the settings.



- Click the **Restore Default Settings** button to restore all parameters excluding network parameters to the factory settings.
- The live view of indoor station will be disabled.

7.5 Video Intercom Device Set-up Tool

Purpose:

You can assign the device to the community, activate and set the device, and configure the network parameters and linked network parameters for the device by using the video intercom device set-up tool.

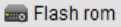
In the device list area, click  **Flash rom** to enter the video intercom device set-up tool.

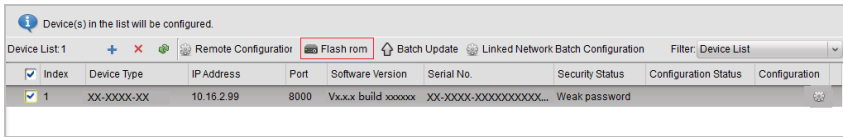

Figure 7-32 Video Device Set-up Tool

7.5.1 Setting a Community Structure

Set a community structure in the video intercom device set-up tool first, based on the real community situation, and then assign devices to the community accordingly.

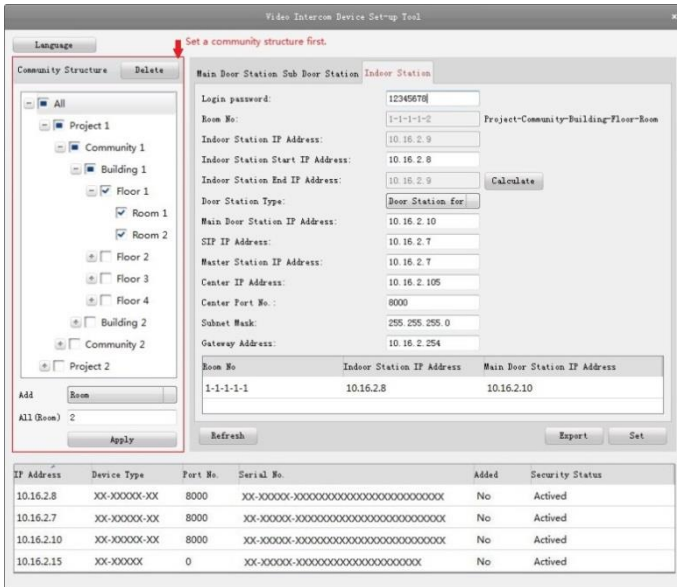

Figure 7-33 Setting a Community Structure

7.5.2 Setting Main/Sub Door Station

Setting Main Door Station

Purpose:

You can activate the online main door station, and configure the building No. for the online main door station.

Steps:

1. Select the community, and press the **Main Door Station** tab to switch to the main door station configuration interface.

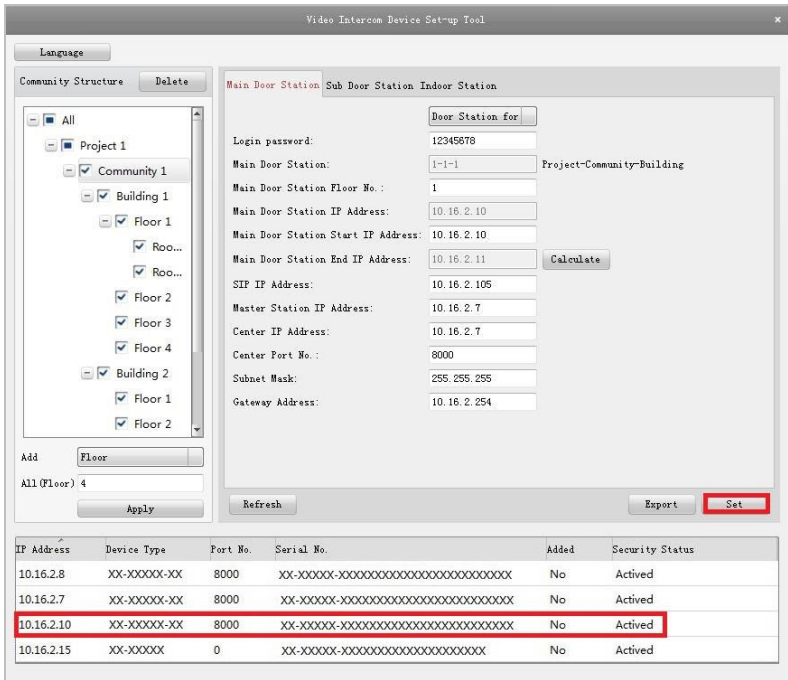

Figure 7-34 Setting Main Door Station

2. Select the door station type from the drop-down list menu: Door Station for Unit, or Door Station for Villa.
3. Enter the main door station start IP address, set the main door station floor No., and then click the **Calculate** button to generate the main door station end IP address and main door station No. (like 1-1-1) automatically.
4. Set the linked network parameters for the main door station: SIP IP address, master station IP address, center IP address, center port No., subnet mask, and gateway address.
5. Select an online door station, enter the login password, and click the **Set** button.



- The default main door station floor No. is 1.
- For the login password, if the main door station has been activated, enter the activation password here. If the main door station is not activated, create a login password here, and the main door station will be activated simultaneously.
- When the device is successfully configured, it prompts the note: Configuring main door station parameters succeeded.

Setting Sub Door Station

Steps:

1. Select the community, and press the **Sub Door Station** tab to switch to the sub door station configuration interface.

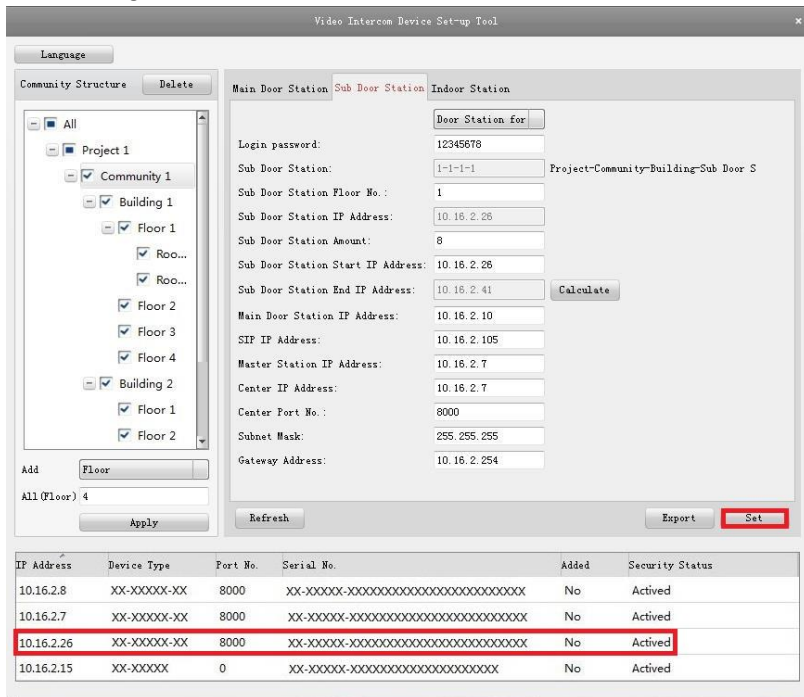

Figure 7-35 Setting Sub Door Station

2. Select the door station type from the drop-down list menu: Door Station for Unit, or Door Station for Villa.
3. Set the sub door station parameters (sub door station amount, floor No., start IP address, end IP address), and then click the **Calculate** button to generate the sub door station end IP address and sub door station No. (like 1-1-1-1) automatically.
4. Set the linked network parameters for the sub door station: main door station IP address, SIP IP address, master station IP address, center IP address, center port No., subnet mask, and gateway address.
5. Select an online door station, enter the login password, and click the **Set** button.



- The default sub door station floor No. is 1.

- Up to 8 sub door stations can be added to a main door station.
- For the login password, if the sub door station has been activated, enter the activation password here. If the sub door station is not activated, create a login password here, and the sub door station will be activated simultaneously.
- When the device is successfully configured, it prompts the note: Configuring main door station parameters succeeded

7.6 Batch Upgrading

In the device list area, click  **Batch Update** to enter the batch upgrading interface.

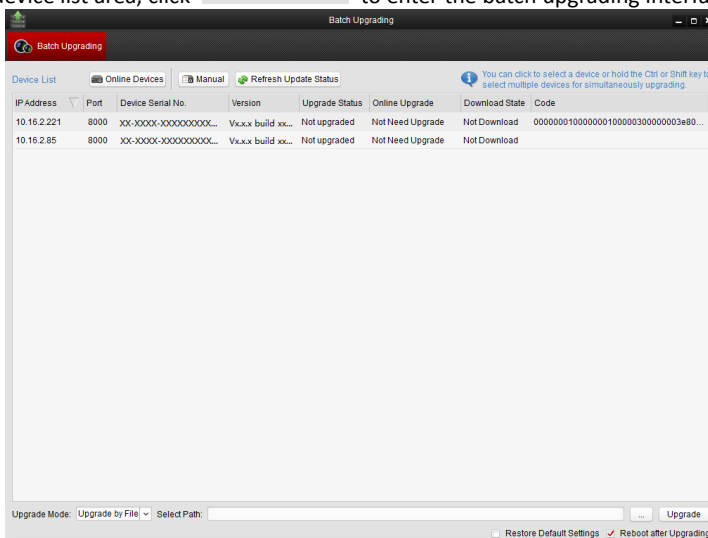

Figure 7-36 Batch Upgrading

7.6.1 Adding Devices for Upgrading

You should add the device to the batch upgrading tool first before upgrading the device. There are 2 ways to add the device: adding online device, and adding by IP address/IP segment.

Adding Online Device

Steps:

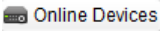
1. In the batch upgrading interface, click the  **Online Devices** to open the online device window.

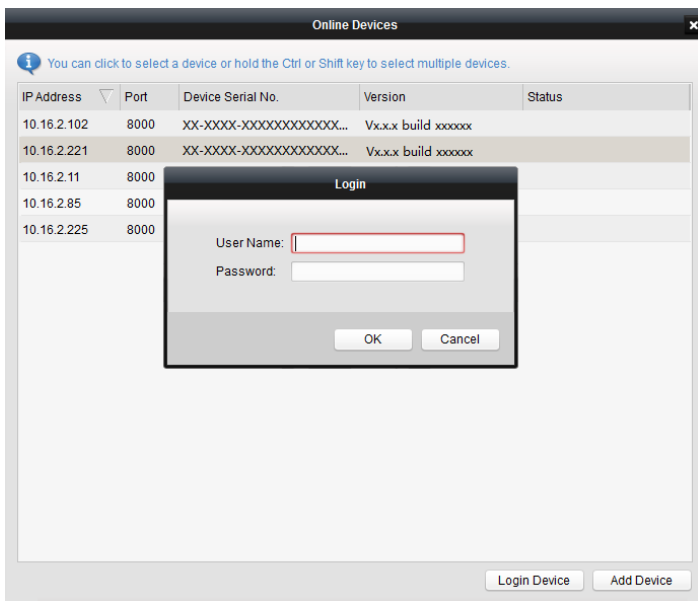

Figure 7-37 Login

2. Select a device, enter the user name and password, and click the **Login Device** button.
3. Click the **Add Device** button, and the device is added to the batch upgrading tool.

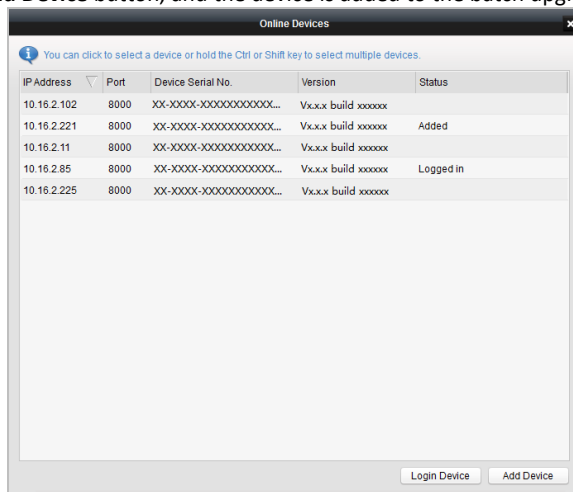

Figure 7-38 Online Devices

Adding by IP Address/IP Segment

Steps:

1. Click the **Manual** button to open the device adding window.
2. Enter the corresponding information (IP address, user name, password, start IP address, end IP address).
3. Click the **Add** button.

The screenshot shows a 'Search' dialog box with two sections for adding devices:

- By IP:**
 - IP Address:
 - Port:
 - User Name:
 - Password:
 -
- By IP Segmen** (likely Segment):
 - Start IP:
 - End IP:
 - Port:
 - User Name:
 - Password:
 -

At the bottom right of the dialog is a button.

Figure 7-39 Adding by IP Address/IP Segment

7.6.2 Upgrading Devices

There are 2 upgrading modes available: upgrading by file, and online upgrading.

Upgrading by File

Upgrading by File: You upgrade the device or devices via the local upgrade files.

Steps:

1. Select a device or multiple devices, and select “Upgrade by File” as the upgrading mode.
2. Click to pop up the window for opening the upgrading file.

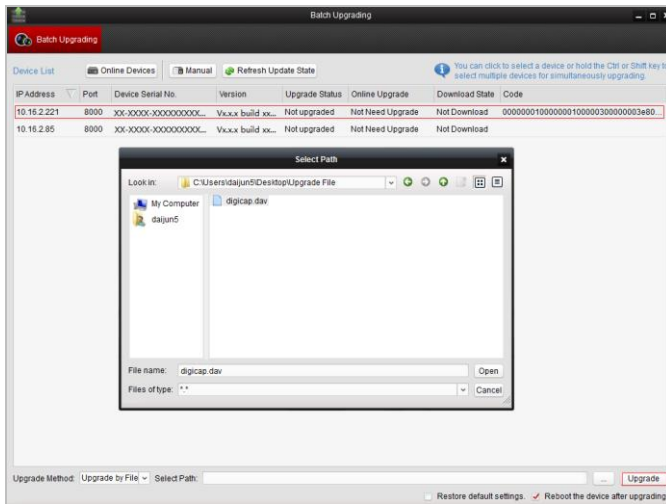

Figure 7-40 Upgrade by File

3. Open the upgrading file, and click the **Upgrade** button.

Online Upgrading

Online Upgrading: The batch upgrading tool will search the latest upgrading file for the device automatically. You upgrade the device or devices via the local upgrading files.

Steps:

1. Select a device or multiple devices, and select “Online Upgrading” as the upgrading mode.
2. Click the **Download** button. Click the **Upgrade** button after the online upgrading file has been wholly downloaded.

8 Remote Operation via iVMS-4200

The Video Intercom module provides remote control and configuration on video intercom products via the iVMS-4200 client software.

Before remote configure and control the video intercom, you are required to add the device to the software first. Refer to *8.2 Device Management*.

For remote configuration of video intercom device via the iVMS-4200 client software, refer to *8.3 Configuring Devices Remotely via iVMS-4200*.

For the picture storage on storage server, refer to *8.4 Picture Storage*.

For remote control of video intercom devices, please refer to *8.5 Video Intercom Configuration*.

8.1 System Configuration

Purpose:



You can configure the video intercom parameters accordingly.

Steps:

1. Open the System Configuration page.

Path: **Control Panel -> Maintenance and Management -> System Configuration -> Video Intercom.**

2. Click the **Video Intercom** tab to enter the Video Intercom Settings interface.
3. Input the required information.

Ringtone: Click the icon  and select the audio file from the local path for the ringtone of indoor station. Optionally, you can click the icon  for a testing of the audio file.

Max. Ring Duration: Input the maximum duration of the ringtone, ranging from 15 seconds to 60 seconds.

Max. Speaking Duration with Indoor Station: Input the maximum duration of speaking with the indoor station, ranging from 120 seconds to 600 seconds.

Max. Speaking Duration with Door Station: Input the maximum duration of speaking with the door station, ranging from 90 seconds to 120 seconds.

Card Reader Type: Select the card reader to issue cards.

4. Click **Save** to save the settings.

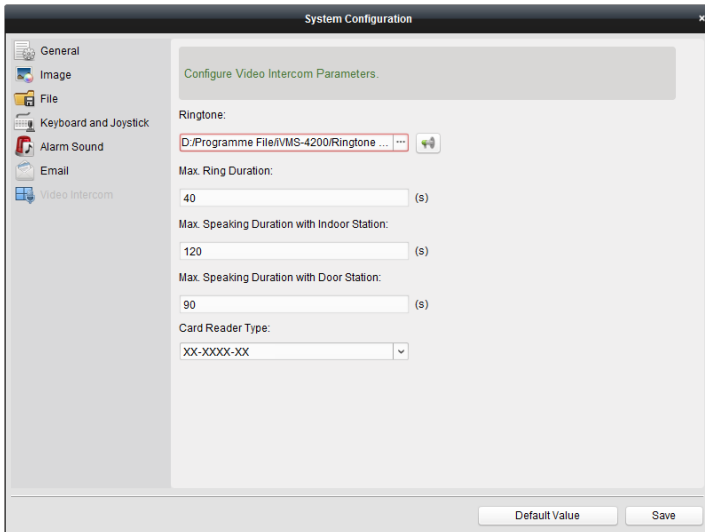

Figure 8-1 System Configuration Interface

8.2 Device Management

Purpose:

Device management includes device activation, adding device, editing device, and deleting device, and so on.

After running the iVMS-4200, video intercom devices should be added to the client software for remote configuration and management.

8.2.1 Adding Video Intercom Devices



- You can add at most 512 indoor stations and master stations in total to the iVMS-4200, and add at most 16 door stations to the iVMS-4200.
- For video intercom devices, you are required to create the password to activate them before they can be added to the software and work properly. For device activation via creating password, please refer *User Manual of iVMS-4200 (Video Intercom) V2.4.2* in the disk for detail steps.
- You can add online video intercom devices, and add them manually. Here take adding online video intercom devices as example. For adding video intercom devices manually, please refer *User Manual of iVMS-4200 (Video Intercom) V2.4.2* in the disk for detail steps.

Steps:



1. Click the  icon on the control panel, or click **Tools->Device Management** to open the Device Management page.
2. Click the **Server** tab.

To add indoor station or master station:

- 1) Click **Add New Device Type** to enter add new device type interface.
Select **Indoor Station/Master Station** and click **OK**.

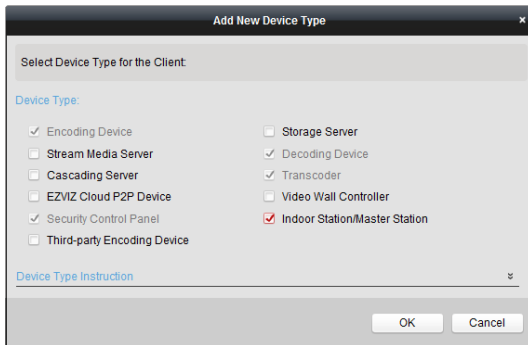

Figure 8-2 Adding New Device Type

- 2) In the **Server** tab, Video Intercom Device will display, select **Video Intercom Device** and add indoor station and master station.

To add door station:

In the **Server** tab, select **Encoding Device/Outdoor Device** and add door station.

3. The active online devices in the same local subnet with the client software will be displayed on the **Online Device** area. You can click the **Refresh Every 60s** button to refresh the information of the online devices.

Online Device (5)							Refresh Every 60s
IP	Device Type	Firmware Version	Security	Server Port	Start Time	Added	
10.16.2.11	XX-XXXX-XX	Vx.x.x build xxxxxx	Active	8000	2016-07-05 09:21:55	No	
10.16.2.85	XX-XXXX-XX	Vx.x.x build xxxxxx	Active	8000	2019-01-21 21:43:24	Yes	
10.16.2.102	XX-XXXX-XX	Vx.x.x build xxxxxx	Active	8000	2016-07-05 09:33:52	No	

Figure 8-3 Online Device



- To add online devices to the software, you are required to change the device IP address to the same subnet with your computer first.
4. Select the devices to be added from the list.

5. Click **Add to Client** to open the device adding dialog box.
6. Input the required information.
 - Nickname:** Edit a name for the device as you want.
 - Address:** Input the device's IP address. The IP address of the device is obtained automatically in this adding mode.
 - Port:** Input the device's port No.. The default value is 8000.
 - User Name:** Input the device's user name. By default, the user name is admin.
 - Password:** Input the device password. By default, the password is **12345**.
7. Optionally, you can check the checkbox **Export to Group** to create a group by the device name. All the channels of the device will be imported to the corresponding group by default.



- iVMS-4200 also provides a method to add the offline devices. Check the checkbox **Add Offline Device**, input the required information and the device channel number and alarm input number, and then click **Add**. When the offline device comes online, the software will connect it automatically.
8. Click **Add** to add the device.

Figure 8-4 Adding Device by IP/Domain



Add Multiple Online Devices

If you want to add multiple online devices to the client software, click and hold Ctrl key to select multiple devices, and click **Add to Client** to open the device adding dialog box.

In the pop-up message box, enter the user name and password for the devices to be added.

Add All the Online Devices

If you want to add all the online devices to the client software, click **Add All** and click **OK** in the pop-up message box. Then enter the user name and password for the devices to be added.

8.2.2 Modifying Network Information

Select the device from the online list, click **Modify Netinfo**, and then you can modify the network information of the selected device.

The screenshot shows a dialog box titled "Modify Network Parameter". It is divided into two main sections: "Device Information" and "Network Information".

Device Information:

- MAC Address: 44-19-b6-5e-fb-4a (with a Copy button)
- Software Version: V5.3.0build 150513 (with a Copy button)
- Device Serial No.: DS-2CD2312-I20140806CCCH475372976 (with a Copy button)

Network Information:

- DHCP
- Port: 8000
- IPv4(Don't Save)
- IP Address: 10.16.2.225
- Subnet Mask: 255.255.255.0
- Gateway: 10.16.2.254
- IPv6(Don't Save)
- Password: (empty field)

At the bottom of the dialog are "OK" and "Cancel" buttons.

Figure 8-5 Modifying Network Parameter



You should enter the admin password of the device in the **Password** field of the pop-up window to modify the parameters.

8.2.3 Resetting Password

According to the different video intercom devices, the software provides two different methods for restoring the default password or resetting the password.

Select the device from the online device list, click **Reset Password**.

Option 1:

If the window with import file button, key importing mode drop-down list, password and confirm password field pops up, follow the steps below to reset the password:



This option is available to door stations.

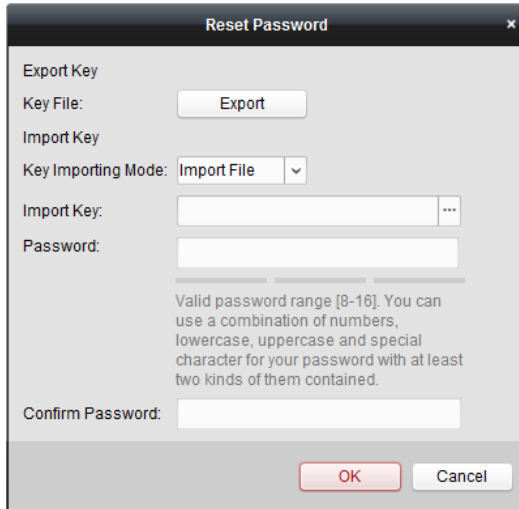



Figure 8-6 Resetting Password (Option 1)

1. Click **Export** to save the device file on your computer.
2. Send the file to our technical engineers.
3. Our technical engineer will send you a file to you. After receiving a file from the technical engineer, select **Import File** from Key Importing Mode drop-down list and click  to import the file.
4. Input new password in text fields of **Password** and **Confirm Password**.
5. Click **OK** to reset the password.

STRONG PASSWORD RECOMMENDED– *We highly recommend you create a strong password of your own choosing (Using a minimum of 8 characters, including at least three of the following categories: upper case letters, lower case letters, numbers, and special characters.) in order to increase the security of your product. And we recommend you reset your password regularly, especially in the high security system, resetting the password monthly or weekly can better protect your product.*



Option 2:

If the window with import file and export file buttons, password and confirm password field pops up, follow the steps below to reset the password:

Note: This option is available to indoor stations and master stations.

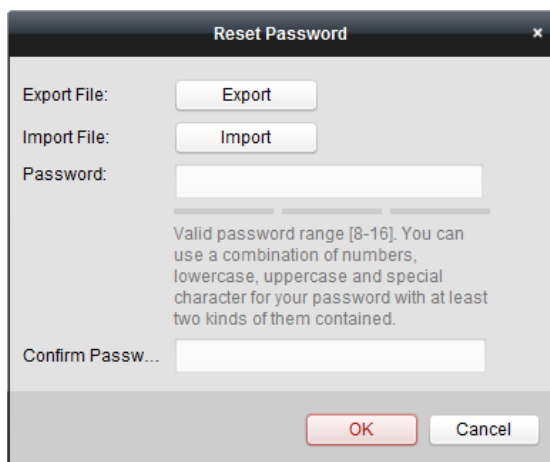

Figure 8-7 Resetting Password (Option 2)

1. Click **Export** to save the device file on your computer.
2. Send the file to our technical engineers.
3. Click **Import** and select the file received from the technical engineer.
4. Input new password in text fields of **Password** and **Confirm Password**.
5. Click **OK** to reset the password.

STRONG PASSWORD RECOMMENDED— We highly recommend you create a strong password of your own choosing (Using a minimum of 8 characters, including at least three of the following categories: upper case letters, lower case letters, numbers, and special characters.) in order to increase the security of your product. And we recommend you reset your password regularly, especially in the high security system, resetting the password monthly or weekly can better protect your product.



8.3 Configuring Devices Remotely via iVMS-4200

Configuring devices remotely via iVMS-4200 is the same with that via Batch Configuration Tool, please refer 7.4 *Configuring Devices Remotely* for detail steps.

8.4 Picture Storage

When the video intercom device is under armed status, it will capture the picture automatically after unlocking the door. The captured picture can be uploaded and stored in the storage server.

When starting the live view of door station via iVMS-4200, you can capture the live view picture. The captured picture can be uploaded and stored in the storage server.



- This function is only available to door stations.
- You are required to add storage server to the iVMS-4200, and format the HDDs first before uploading and storing captured pictures.

8.4.1 Adding Storage Server

Before you start:

The storage server application software needs to be installed and it is packed in the iVMS-4200 software package. When installing the iVMS-4200, check the checkbox of **Storage Server** to enable the installation of storage server.

1. Click the icon  on the desktop to run the storage server.
2. Open the Device Management page and click the **Server** tab.
3. Click **Add New Device Type**, select **Storage Server** and click **OK**.

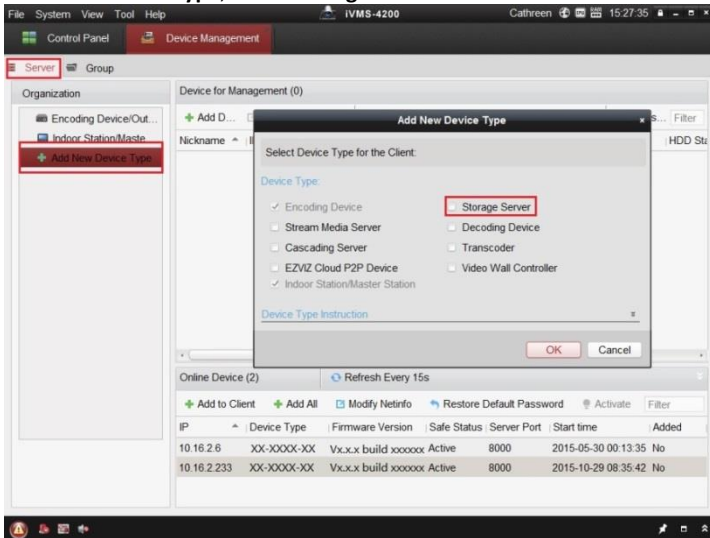

Figure 8-8 Adding Storage Server Type

4. Click **Storage Server** on the list to enter the Storage Server Adding interface.



For adding the storage server, please refer to *User Manual of iVMS-4200 (Video Intercom) V2.4.2* in the disk.

8.4.2 Formatting the HDDs

The HDDs of the storage server need to be formatted for the captured picture storage.

Steps:

1. Select the added storage server from the list and click **Remote Config**.
2. Click **Storage->General** to enter the HDD Formatting interface.
3. Select the HDD from the list and click **Format**. You can check the formatting process from the process bar and the status of the formatted HDD changes from *Unformatted* to *Normal Status*.

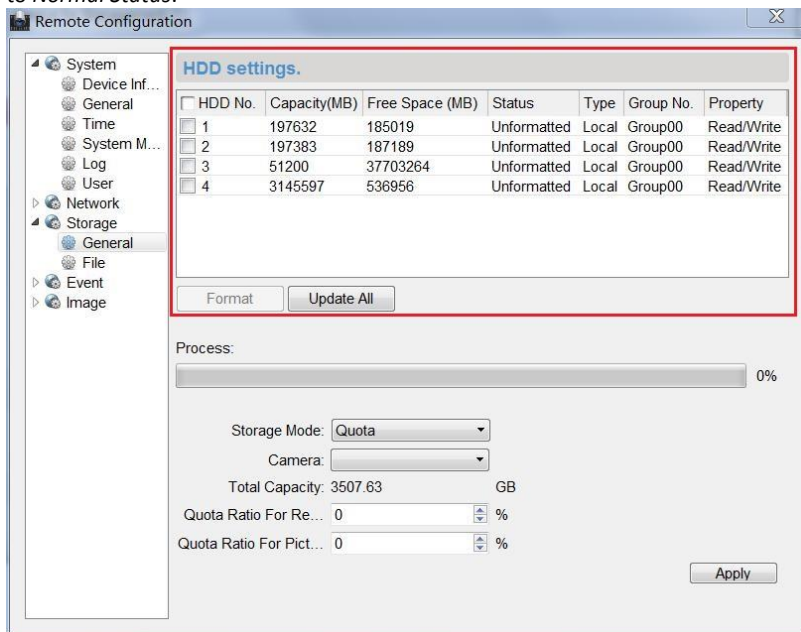

Figure 8-9 Formatting HDDs



Formatting the HDDs is to pre-allocate the disk space for storage and the original data of the formatted HDDs will be deleted.

8.4.3 Configuring Storage Server Picture Storage

Before you start:

The storage server needs to be added to the client software and the HDDs need to be formatted for the captured pictures storage.

Steps:

1. Open the Record Schedule page.
2. Select the camera from the Camera Group list.
3. Select the storage server from the **Storage Server** drop-down list.



You can click **Storage Server Management** to add, edit or delete the storage server.

4. Check the checkbox of **Picture Storage** to store the alarm pictures of the camera when event occurs.

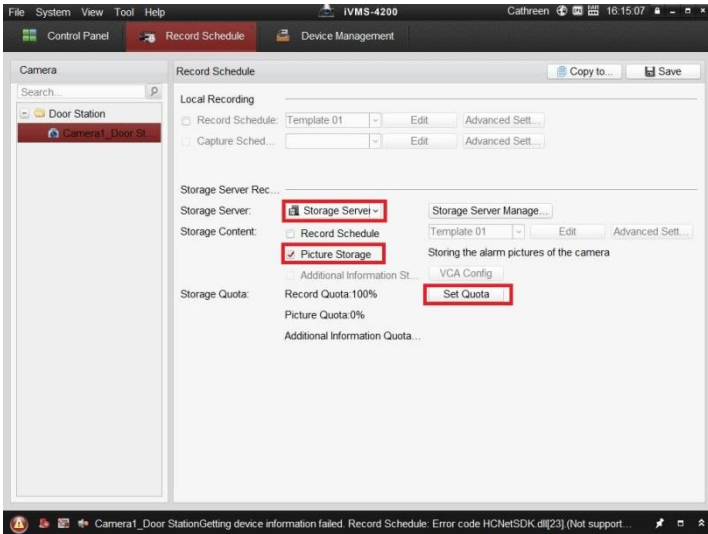

Figure 8-10 Setting Storage Server

5. Click **Set Quota** to enter the HDD management interface of the storage server. You can set the corresponding quota ratio for captured picture information.

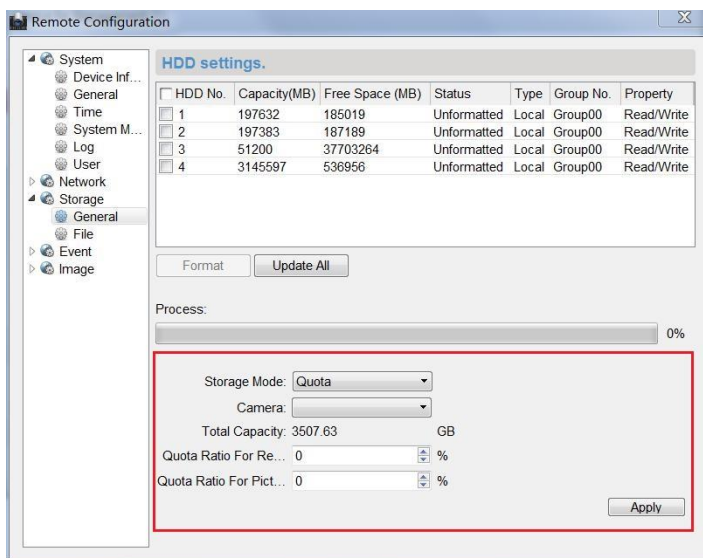

Figure 8-11 Setting Quota

Example: If you set the picture quota as 60%, then the 60% of the storage space can be used for storing the captured pictures.

6. Click **Save** to save the settings.

8.5 Video Intercom Configuration



Click the icon on the control panel of iVMS-4200 or click **View -> Video Intercom** to open the Video Intercom page. On the Video Intercom page, you can control video intercom devices remotely. There are 4 modules on the Video Intercom page:

Video Intercom: Start visual communication with door stations, and manage incoming calls from indoor stations and door stations and master stations. Refer *8.5.2 Video Intercom* for detail steps.

Group Management: Construct virtual communities according to the real community situations, and assign door stations and indoor stations to the community accordingly. Refer *8.5.1 Group Management* for detail steps.



You should manage groups first before starting the visual communication with indoor stations or door stations.

Card Management: Add unauthorized cards to the iVMS-4200, and issue card to the door station via the iVMS-4200. Refer *8.5.3 Card Management* for detail steps.



Once you issue cards via the iVMS-4200, the card issuing function of the corresponding door station will be disabled automatically.

Notice Management: Send information to indoor stations, search information, search call logs, and search unlocking logs. Refer *8.5.4 Notice Management* for detail steps.

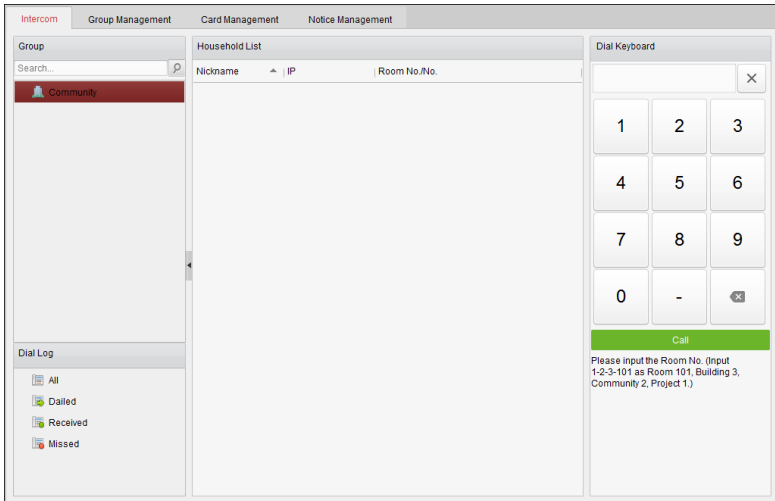

Figure 8-12 Intercom Interface

8.5.1 Group Management

Purpose:

You can add groups to community, outer door station, or other, and assign devices to each group.

Enter **Control Panel -> Video Intercom -> Group Management** to add, edit, and delete groups. Three group types can be selected: community, outer door station and other.

Adding Group

1. Click the **Group Management** tab to enter the group management interface.

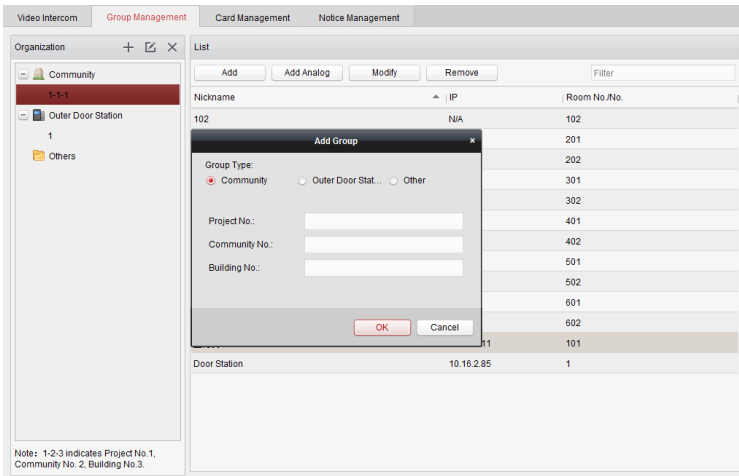

Figure 8-13 Adding Group

2. Click to pop up group adding window, and input the corresponding information accordingly.
 - Select **Community** as group type, and then Input the Community No., building No., and Unit No. to set the community structure, as shown in the figure below.

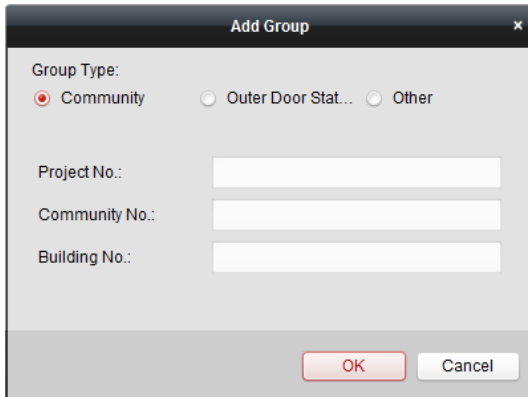

Figure 8-14 Adding Community

- Select **Outer Door Station** as group type, and then input the outer door station No. (Range: 1 to 9) to set the outer door station, as shown in the figure below.

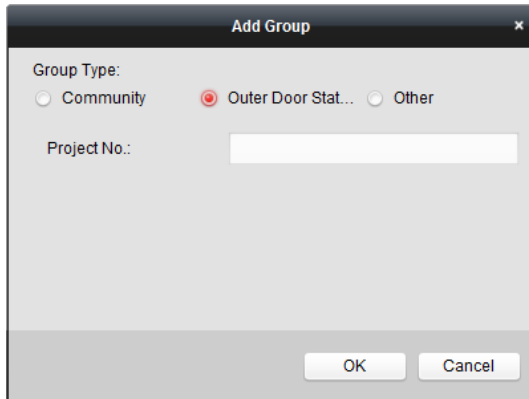

Figure 8-15 Adding Outer Door Station

- Select **Other** as group type, and then input the group name.

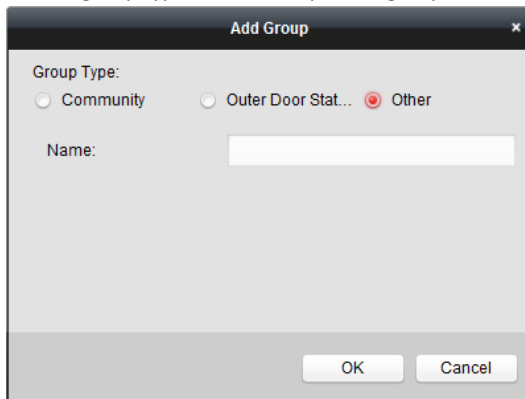

Figure 8-16 Adding Other

For example: You can name the group as administrator, entrance guard and cleaning staff, etc.



When selecting **Other** as the group type, you can set different groups for staff other than residents, such as administrator, security guard and cleaning staff, etc., and you can assign cards to these staff and configure different permissions to them.

3. Click **OK** to complete group adding.

Assigning IP Devices to Group

After adding groups to Community, Outer Door Station, or Other, you should assign devices to the group.

For example: You should assign indoor stations and door stations to the group 1-1-1 in Community.

1. Click **Add** to enter the Add Resident Interface and the video intercom devices added to the client software will be listed, as shown in the figure below.

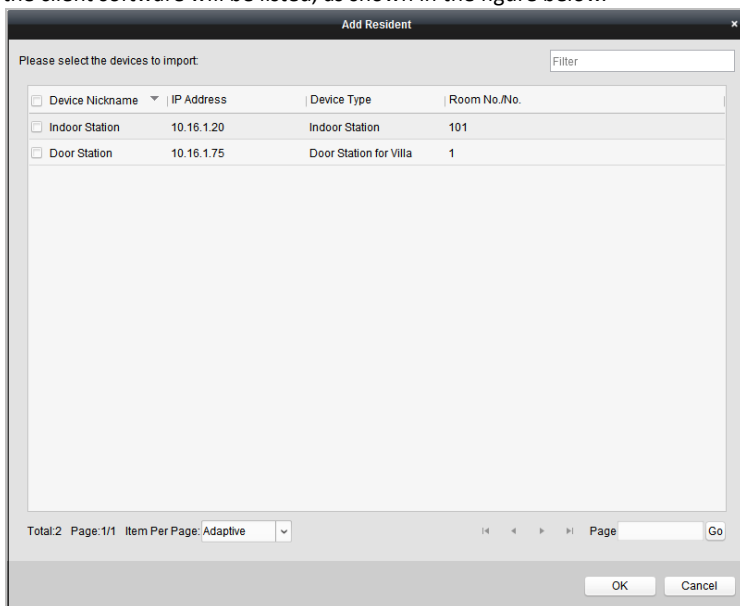

Figure 8-17 Adding Resident

2. Check the checkbox of device.
 - Indoor Station:** set a Room No. for the indoor station.
 - Door Station:** set a No. for the door station.
3. Click **OK** to save the settings.

Assigning Analog Devices to Group



When assigning analog devices to group, only analog indoor stations are supported.

1. Click **Add Analog** to pop up analog device adding window. You can add analog devices singly or in batch.

- Adding Devices in Batch: Enter the start floor and end floor, and set the room numbers.

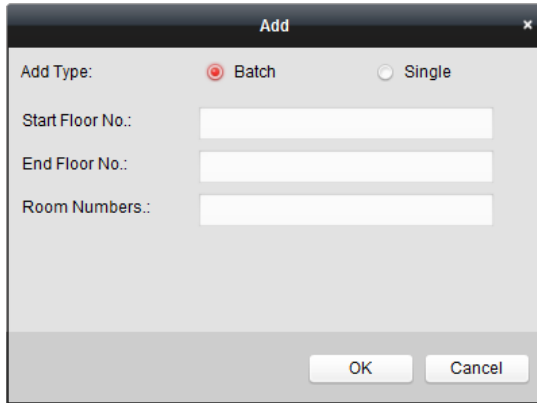

Figure 8-18 Adding Devices in Batch



Room Numbers here refers to the room numbers in each floor.

- Adding Devices Singly: Enter the room No..

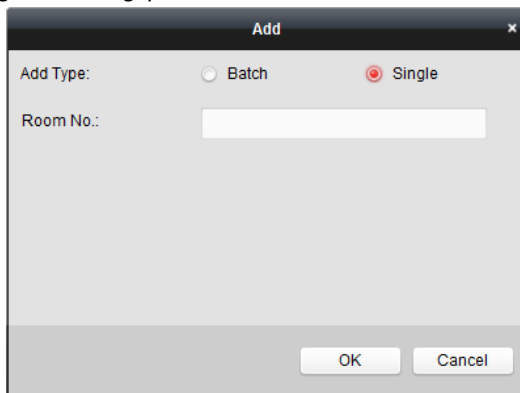

Figure 8-19 Adding Device Singly



The room No. format is like 101.

2. Click **OK** to save the settings.

Modifying Device Information

1. Select an added device.
2. Click **Modify** to enter the device modifying interface.

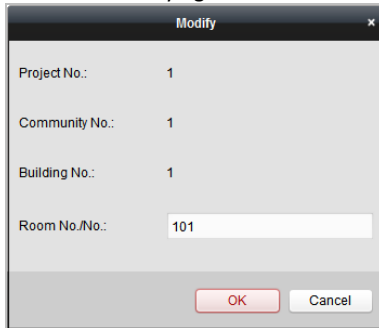

Figure 8-20 Modifying Device Information

3. Click **OK** to complete the device modifying operation.

Deleting Device

1. Select an added device.
2. Click **Remove** to pop up a dialog box.

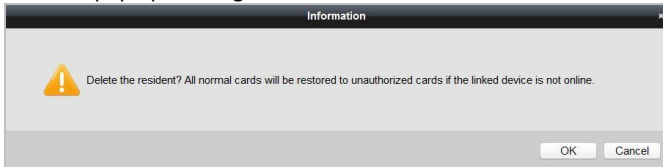

Figure 8-21 Information

3. Click **OK** to complete the group deleting operation.

8.5.2 Video Intercom

Receiving Call from Door Station

Purpose:

When the door station has been added to the client software, you can call iVMS-4200 via door station.

Before you start:

- Make sure the door station has been added to the iVMS-4200 client software.

- Make sure the SIP server IP address of the door station is not configured (or abnormal).

Steps:

Press **Calling Center** key on the door station.

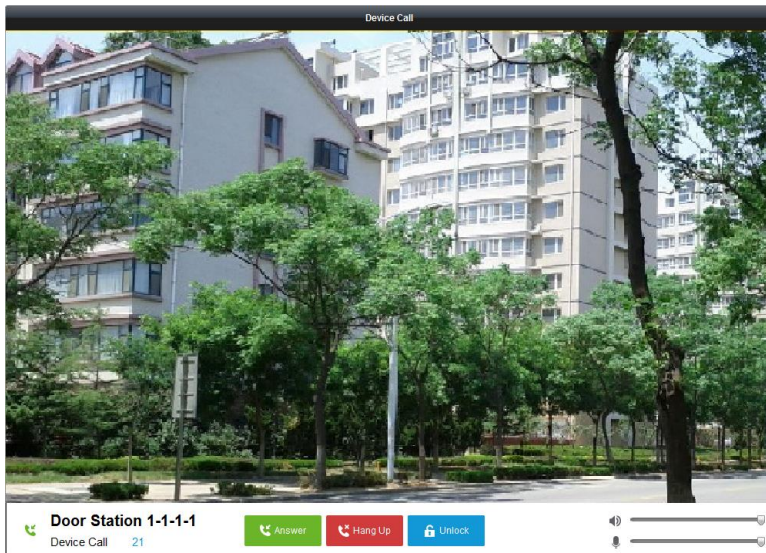

Figure 8-22 Calling from Door Station



- When the SIP server IP of the door station is configured, press **Calling Center** key on the door station to call the master station instead of iVMS-4200.
- Click **Unlock** to unlock the building or villa door via iVMS-4200, no matter whether answering the call from door station or not.
- Click **Answer** to answer the call from door station.
- Click **Hang Up** to end the call from door station.

Call Log

On the Video Intercom tab page, there are four types of call logs you can search: **All**, **Dialed**, **Received**, and **Missed**.

On the dial log area, you can view detail information of the dialog, and click **Call** to start the audiovisual call with the indoor station.

Click  **Clear Log** to clear all logs in the list (optional).

8.5.3 Card Management

Purpose:

You can add unauthorized cards to the community and then you can assign the cards to the corresponding indoor station and door stations.

For example, if there are 3 residents living in Room 401, you can assign 3 cards to No. 401 Indoor Station.

For each indoor station, you can assign multiple cards, and you can assign these cards to the door station in the same building.

Note: Indoor extension does not support **Card Management**.

Before you start:

Make sure the indoor station and door station have been added to the iVMS-4200 client software.

Steps:

Click **Video Intercom -> Card Management** to enter the card management page.

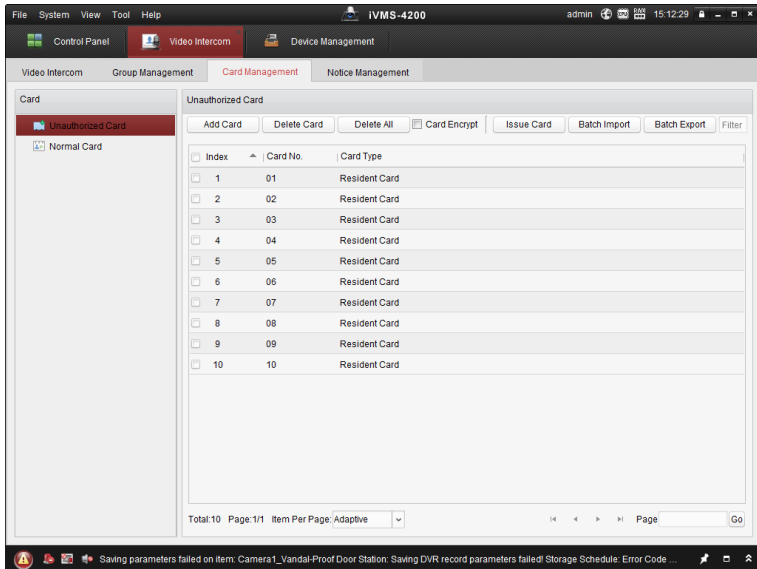

Figure 8-23 Card Management Interface

Adding Card

Steps:

1. Click **Unauthorized Card -> Add Card** to pop up card adding window.

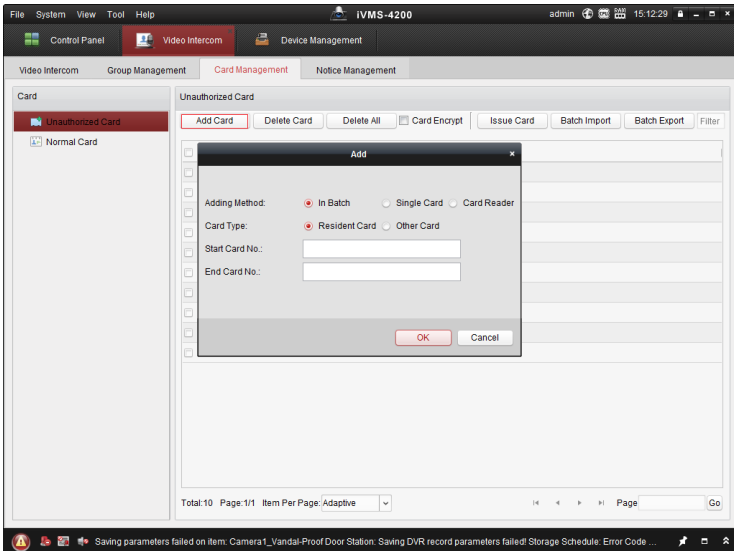

Figure 8-24 Adding Cards in Batch

2. Select card adding mode and card type.



Two types of card are available. Resident Card is used by residents living in the community, and Other Card is used by visitors (guest, serviceman, etc.) in the community.

- If you add card in batch, please set the start card No. and the end card No..
- If you add card singly, please enter the card No..
- If you add card via card reader, please swipe the card in the card reader, and the corresponding card No. will be shown automatically in the Card No. textbox.

3. Click **OK** to accomplish carding adding operation.



- Click **Delete All** to delete all cards added in iVMS-4200.
- Select one or multiple cards, and click **Delete Card** to delete selected cards added in iVMS-4200.
- **Card Encrypt** is only available to cards added via card reader. Enabling Card Encrypt can improve the card security to prevent it from being copied. But the same time, the default key of all the available sectors of the card is modified.

Issuing Card

Click **Issue Card** to pop up card issuing window.

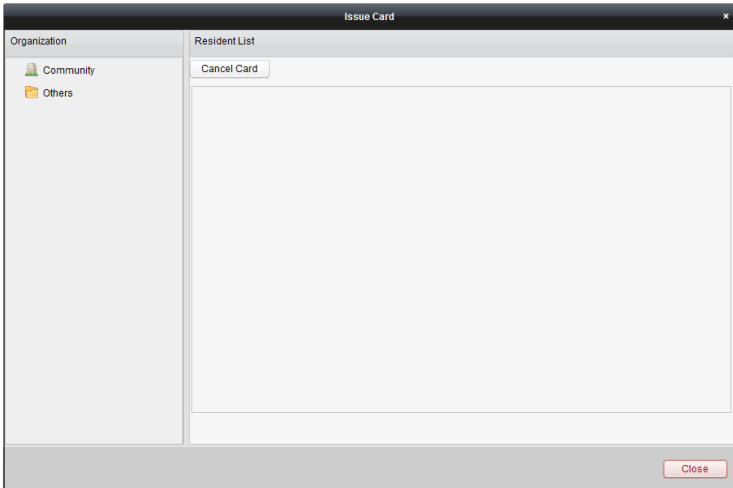

Figure 8-25 Issuing Card

Issuing Resident Cards

Steps:

1. Select **Community** from the organization list (like 1-1-1) and the indoor stations of the community will be listed in the resident list.

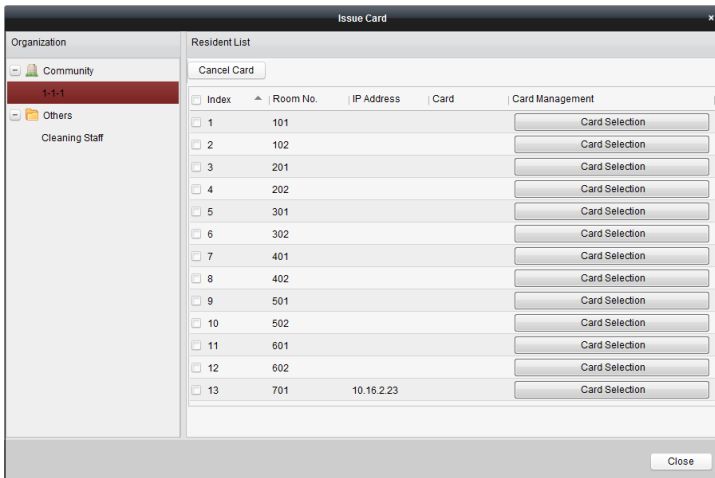

Figure 8-26 Clicking Card Selection

2. Click **Card Selection** to pop up card selection window where unauthorized resident cards are listed.

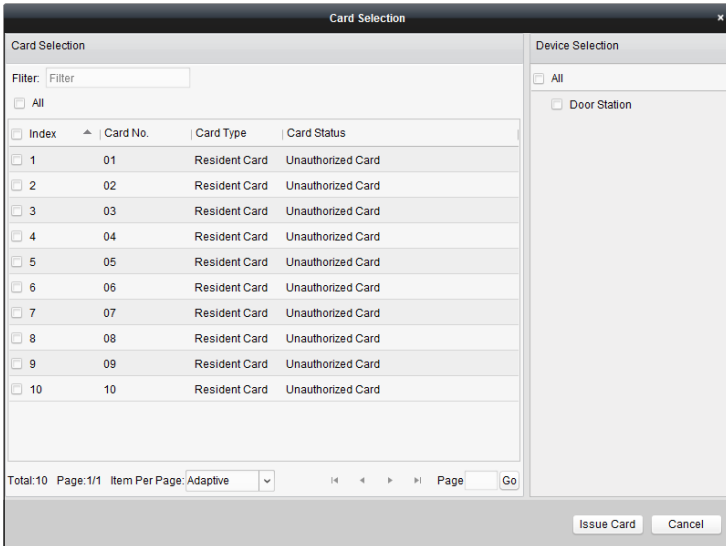

Figure 8-27 Selecting Cards

3. Check the checkboxes of the cards or enter the card No. in the filter textbox you need to assign to the indoor station, and check the checkbox of door stations, doorphones and outer door stations.



Only resident cards can be assigned to indoor stations.

4. Click **Issue Card** to complete the card issuing operation.

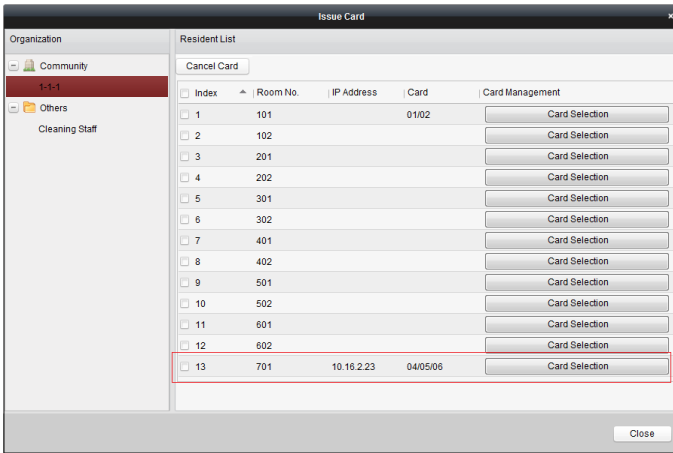

Figure 8-28 Displaying Card Issued



After issuing resident cards to the indoor station, the card No. will also be listed in the resident list.

Issuing Other Cards

Steps:

1. Select **Other** from the group list (like Cleaning Staff).

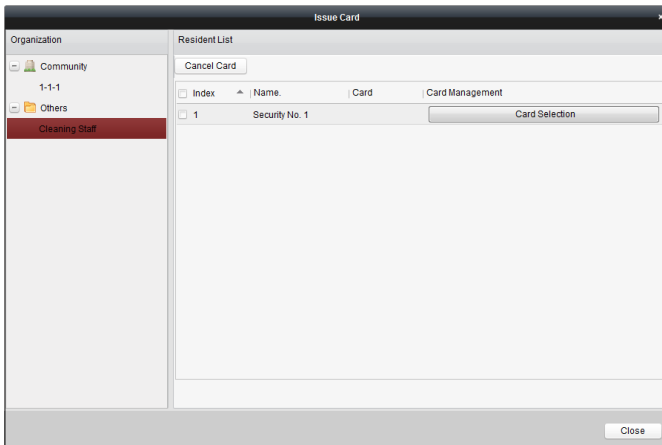

Figure 8-29 Issuing Other Card

- Click **Card Selection** to pop up card selection window where unauthorized other cards are listed.

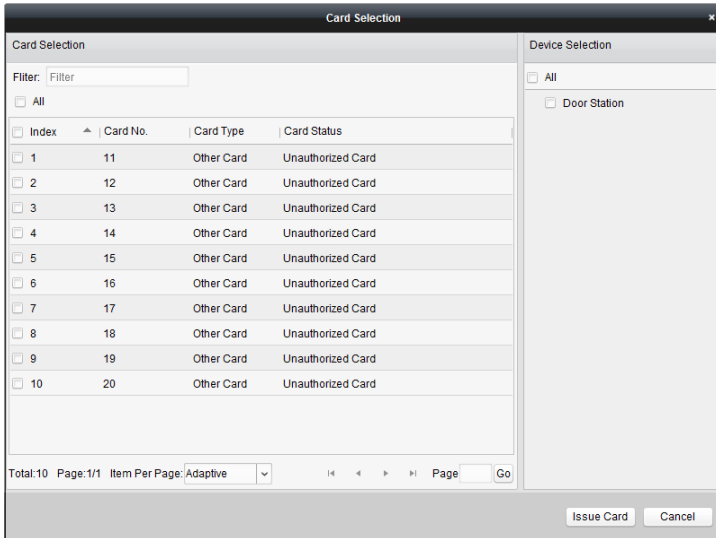

Figure 8-30 Selecting Cards

- Check the checkboxes of the cards or enter the card No. in the filter textbox you need to assign to the person, and check the checkbox of door stations, doorphones and outer door stations.
- Click **Issue Card** to complete the card issuing operation.

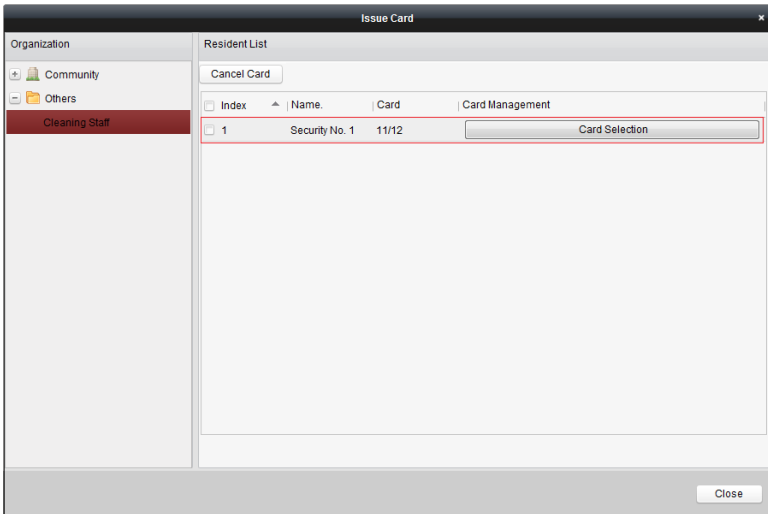

Figure 8-31 Displaying Card Issued



After issuing other cards to the person, the card No. will also be listed in the resident list page.

Canceling Cards

When canceling cards, cards that have been issued will be reset to authorized ones. Via iVMS-4200, there are two ways to cancel the cards which have been issued.

Option 1:

Steps:

1. Select **Community** from the organization list (like 1-1-1) and the indoor stations of the community will be listed in the resident list.

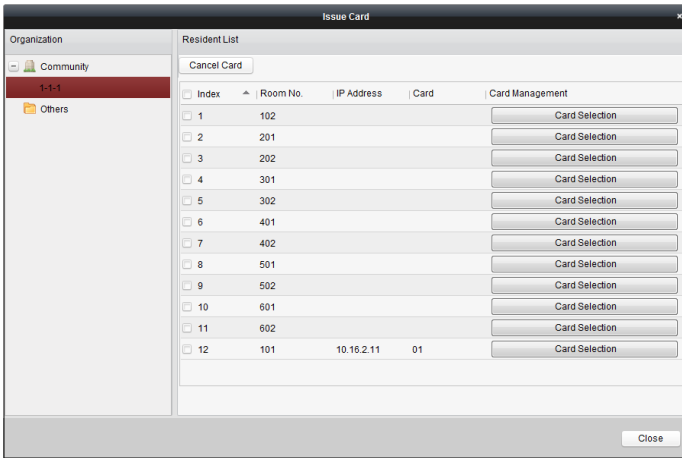

Figure 8-32 Card Selection Interface

- Click **Card Selection** to pop up card selection window where normal cards and unauthorized resident cards are listed.

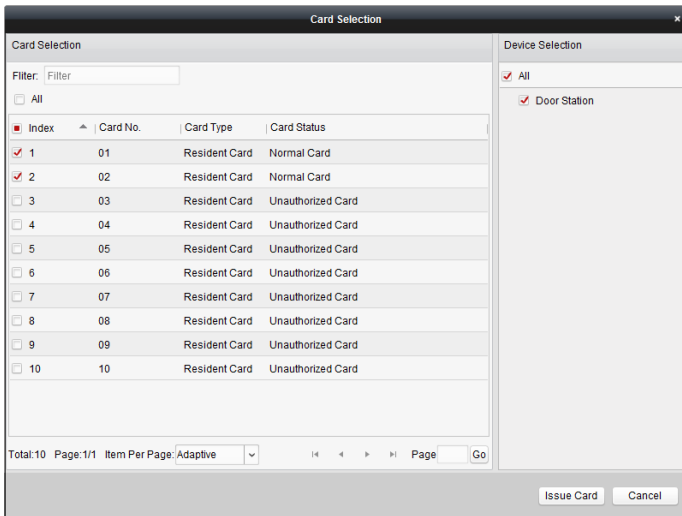

Figure 8-33 Selecting Cards

- Check the checkboxes of the cards that has been issued (normal cards).
- Click **Issue Card** to complete the card canceling operation.

Option 2:

On the card issuing interface, check the checkboxes of Room No. (for resident card) or Name (for other card), click **Cancel Card** to cancel all card issued to the device.



- Through Option 1, you can cancel card from single or certain door stations.
- Through Option 2, you will cancel all issued cards at a time.

Normal Card

Click **Normal Card** to display normal card list. After issuing cards, the issued cards will be listed in the normal card list, as shown in the figure below.

The screenshot shows a web interface with a navigation bar at the top containing 'Video Intercom', 'Group Management', 'Card Management' (highlighted), and 'Notice Management'. On the left, a sidebar has 'Card' selected, with sub-options 'Unauthorized Card' and 'Normal Card' (highlighted). The main area is titled 'Normal Card' and contains a table with the following data:

Index	Card No.	Card Type	Related Resident
1	01	Resident Card	Indoor Station
2	02	Resident Card	Indoor Station
3	14	Other Card	Security No. 1
4	15	Other Card	Security No. 1

At the bottom of the interface, there is a status bar showing 'Total: 4', 'Page: 1/1', 'Item Per Page: Adaptive', and a 'Go' button.

Figure 8-34 Normal Cards Interface

Batch Importing Unauthorized Cards

Steps:

1. Click **Batch Import** to enter the batch import interface, as shown in the figure below.

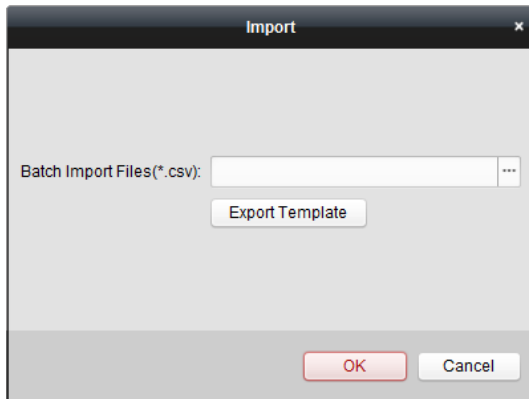

Figure 8-35 Importing File

2. Click **Export Template** to export the template of the batch import file.
3. Fill in the template of the batch import file and save it.
4. Click to select the batch import file and click Open.
5. Click **OK** to start importing the batch import file.

Batch Exporting Unauthorized Cards

Steps:

1. After adding unauthorized cards, and click **Batch Export**.
2. Select the saving file path and click **Save**.
3. After batch exporting the unauthorized cards, the excel will be generated in the saving directory.

8.5.4 Notice Management

Querying Call Logs

Steps:

1. Click **Query Call Logs** to enter the call log querying page.
2. Select the calling status, device type, and set the start time and end time, and click **Query** to search the call log.

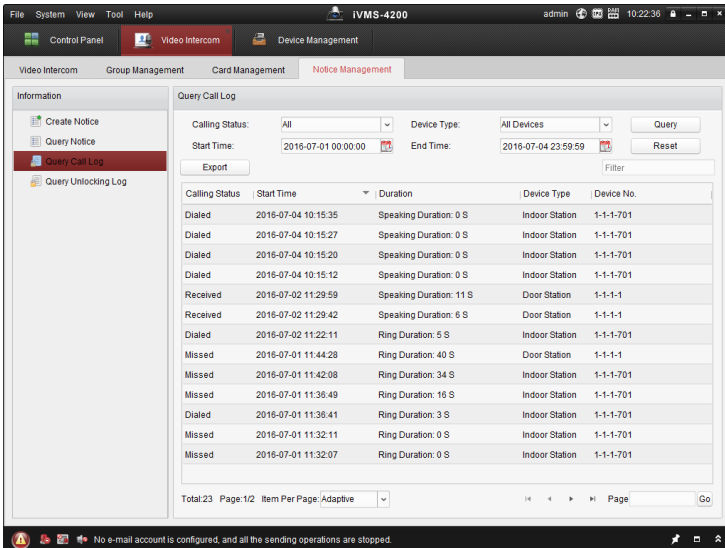

Figure 8-36 Call Log Interface

3. Click **Export** to export the call logs as an excel file.

Querying Unlocking Log

Steps:

1. Click **Query Unlocking Logs** to enter the unlocking log querying page.
2. Select the unlocking type, device type, and set the start time and end time, and click **Query**.

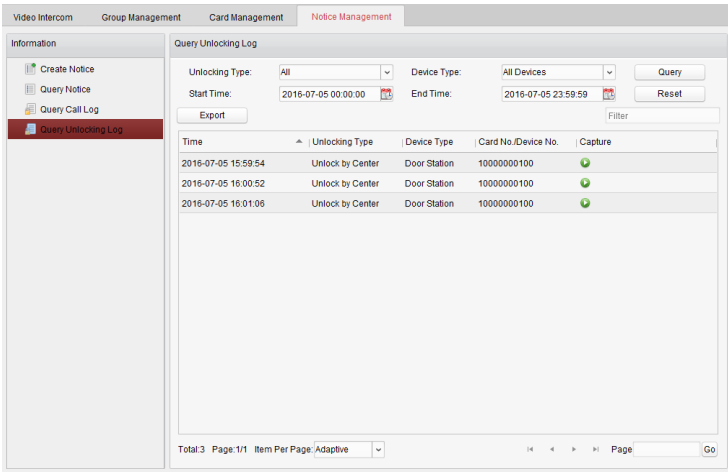

Figure 8-37 Unlocking Log Interface

3. Click **Export** to export the unlocking logs as an excel file.

8.6 Device Arming Control

Steps:

1. Select **Tool->Device Arming Control** to pop up device arming control window.



Figure 8-38 Tool Bar

- Set the arming status of the device as armed, and the alarm information will be auto uploaded to the client software when alarm occurs.

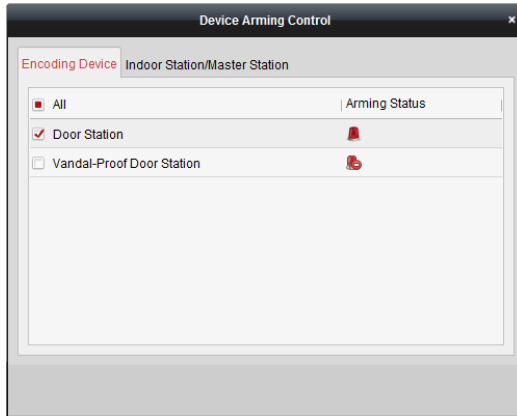

Figure 8-39 Device Arming Control

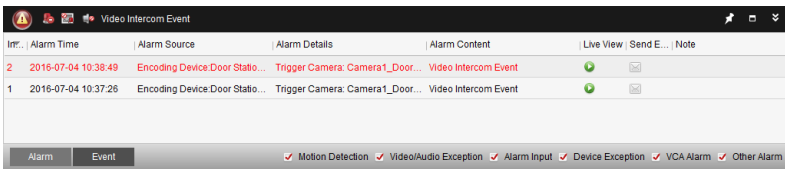

Figure 8-40 Alarm Events



After adding the device to the client software, it will be armed automatically.

9 Local Operation

9.1 Calling Resident

9.1.1 Calling Resident (DS-KV8X02-IM)

You can call the resident by pressing the call button. For device DS-KV8X02-IM, the number of call buttons varies according to its model.

Take the figure of device DS-KV8402-IM as an example.



- For device DS-KV8102-IM, there is only 1 call button.
- For device DS-KV8202-IM, there are 2 call buttons.
- For device DS-KV8402-IM, there are 4 call buttons.
- Default settings of call button: when you press the call button, it calls the resident; and when you hold down the call button, it calls the center.
- You can change the calling mode of the call button via Batch Configuration Tool or iVMS-4200 client software. See 7.4.2 *Video Intercom* for detail steps.

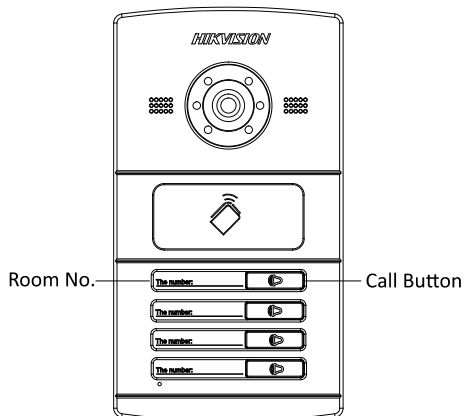

Figure 9-1 Call Button of DS-KV8402-IM

Steps:

1. Press the corresponding call button of the resident.
2. The resident can receive/decline the video call, unlock the door, call the elevator, etc.



- When the video intercom between you and the resident is realized, you can speak to the resident, and the live view of door station will be displayed on the connected indoor station.
- When live view of door station is displayed on other devices or door station is calling resident, the door station will detect the brightness of video. When the brightness is lower than the expected threshold, the supplement light will be enabled.
- When the supplement light is enabled, the backlight of key will be auto-enabled, otherwise, the door station will detect the brightness of live view and enable the backlight of key when the brightness of live view is lower than expected threshold.

9.1.2 Calling Resident (DS-KV8102-XP)

You can call the resident by pressing the call button. For device DS-KV8102-IP/VP, there is only 1 call button.



- Default settings of call button: when you press the call button, it calls the resident; and when you hold down the call button, it calls the center.
- You can change the calling mode of the call button via Batch Configuration Tool or iVMS-4200 client software. See 7.4.2 *Video Intercom* for detail steps.

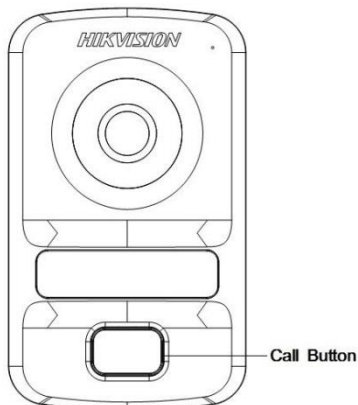

Figure 9-2 Call Button of DS-KV8102-XP

Steps:

1. Press the corresponding call button of the resident.

2. The resident can receive/decline the video call, unlock the door, call the elevator, etc.



- When the video intercom between you and the resident is realized, you can speak to the resident, and the live view of door station will be displayed on the connected indoor station.
- When live view of door station is displayed on other devices or door station is calling resident, the door station will detect the brightness of video. When the brightness is lower than the expected threshold, the supplement light will be enabled.
- When the supplement light is enabled, the backlight of key will be auto-enabled, otherwise, the door station will detect the brightness of live view and enable the backlight of key when the brightness of live view is lower than expected threshold.

9.2 Issuing Card

Purpose:

You can assign the card to the door station or doorphone by issuing cards. You can issue cards by swiping the main card with the door station, or issue the card with iVMS-4200 client software. For more information about issuing card by iVMS-4200, please refer to the user manual in the disk.

Steps:

1. Swipe the main card on the card induction area to enter the card issuing mode.
2. Hear a voice prompt of the device: Issuing card started.
3. Swipe the unauthorized sub card in turn on the card induction area.
4. Hear a voice prompt of the device (Issuing card finished.) after issuing each card successfully.



- Only Mifare card supported, and Mifare card with non-standard shape is recommended.
- No more than 256 cards can be issued to and managed by V series door station. A voice prompt (Card amount exceeds limit.) can be heard when the issued card amount exceeds the upper limit.
- Swipe the main card again or perform no operation for more than 10s, the device will exit the card issuing mode automatically.
- After issuing cards with client software, the local card issuing function will be disabled.
- For each main door station, at most 8 sub door stations can be added.

9.3 Unlocking Door

Purpose:

After issuing cards, you can unlock the door by swiping the issued card.

Step:

1. Swipe the card on the card induction area.
2. Hear a voice prompt of the device: Door is open.



You cannot unlock the door by swiping the main card.

Appendix

Installation Notice

While installing the door station, please make sure that the distance between any two devices is far as possible to avoid the howling and echo. The distance between two devices is recommended to be longer than 10 meters.



Devices here refer to indoor station, door station, doorphone and master station.

Wiring Cables

Cable	Specification
Power Cord of Door Station	RVV 2*1.0
Network Cable of Door Station	UTP-five Categories
Door Lock Wiring (With Door Magnetic)	RVV 4*1.0
Door Lock Wiring (Without Door Magnetic)	RVV 2*1.0
Exit Button Wiring	RVV 2*0.5



First Choice for Security Professionals